

ILNSS

Network For Position On Lunar Surface And
Interplanetary Prototype

Thanapat Chotipun
Witchaphas Phopumyen
Tapaneeya Odmung
Bodindecha (Sing Singhaseni) School



Overview

What is ILNSS?

Interplanetary satellites network providing location info for deep space missions and colonization

ILNSS Mission has got many factors and operation phases to make a satellite network with a reusable deployer, fast, reliable, and accurate satellite systems. ILNSS network would setup and operate as circular orbit from proximal altitude depends on shape and radius of target planet's surface. ILNSS use six orbit parameters for Kepler's orbit to create an orbit, satellites should-be position by calculation which also include another operation useful for ILNSS orbital design.



Why we need ILNSS?

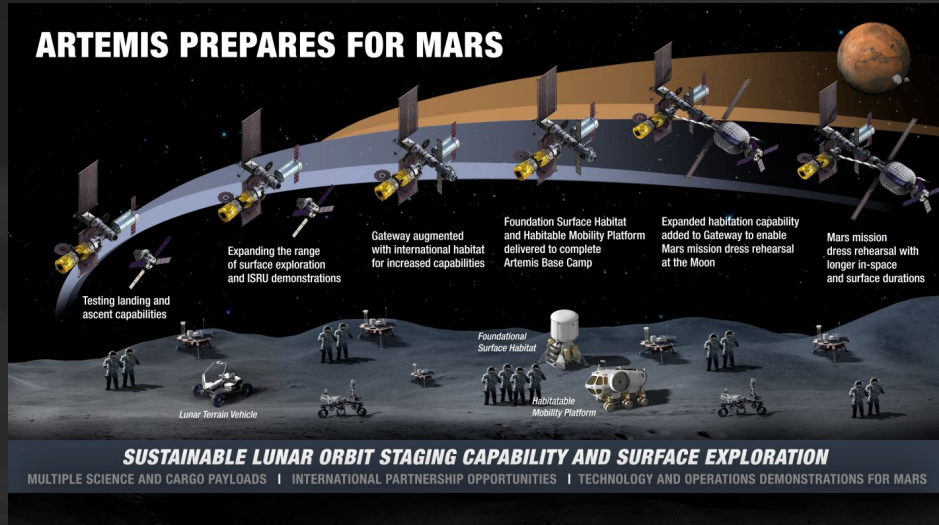

ILNSS will support Moon to Mars mission and another human deep space mission as sustainability of humans on another planet and in space. With ILNSS it will be more easier to track creations and lives as isolated systems from the Earth.



Concept of ILNSS

Concept of ILNSS - Constellation

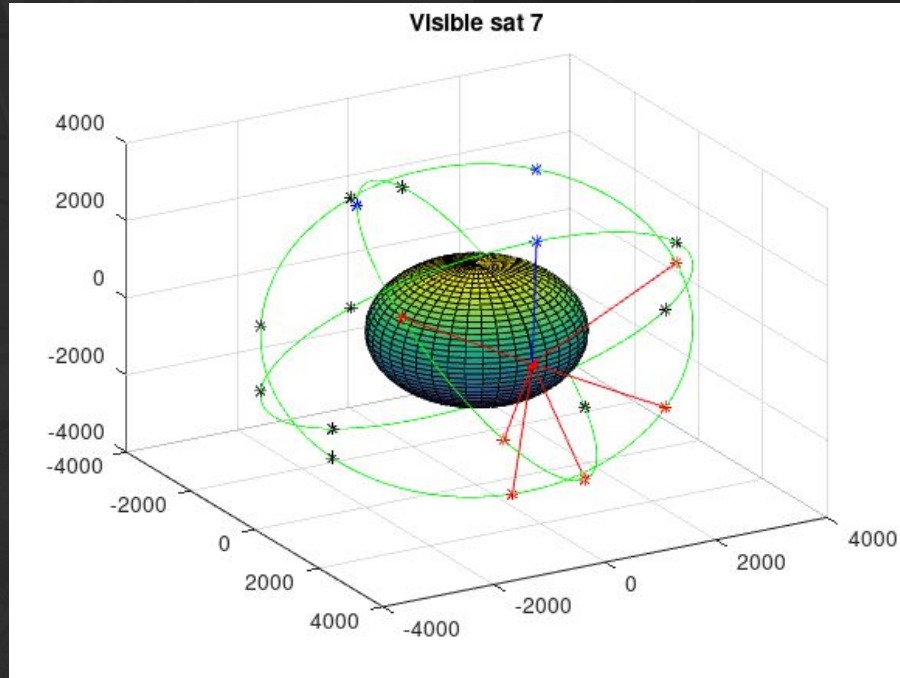

ILNSS is consisted of constellation of CubeSat above planet sphere at proximal altitude for signals and coverage areas of satellites, ie. for Lunar, we use 2,500 k.m. from the surface

Concept of ILNSS - Coverage Area

ILNSS can covered up to..

200 kilometers

Higher from the Lunar surface

Coverage area is calculated using Pythagorean triangle of half power beamwidth and altitude of satellite, ILNSS plans to make the network fully coverage the planet.

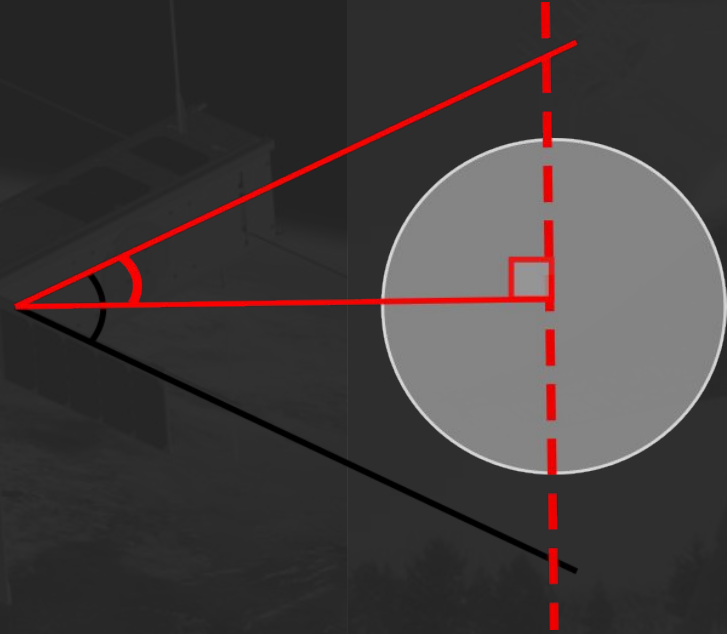

Concept of ILNSS - Coordinate system

ILNSS use selenographic coordinates to provide user's location on the target planet which is similar to GPS which can be transformed to Lat-Long or Cartesian coordinate

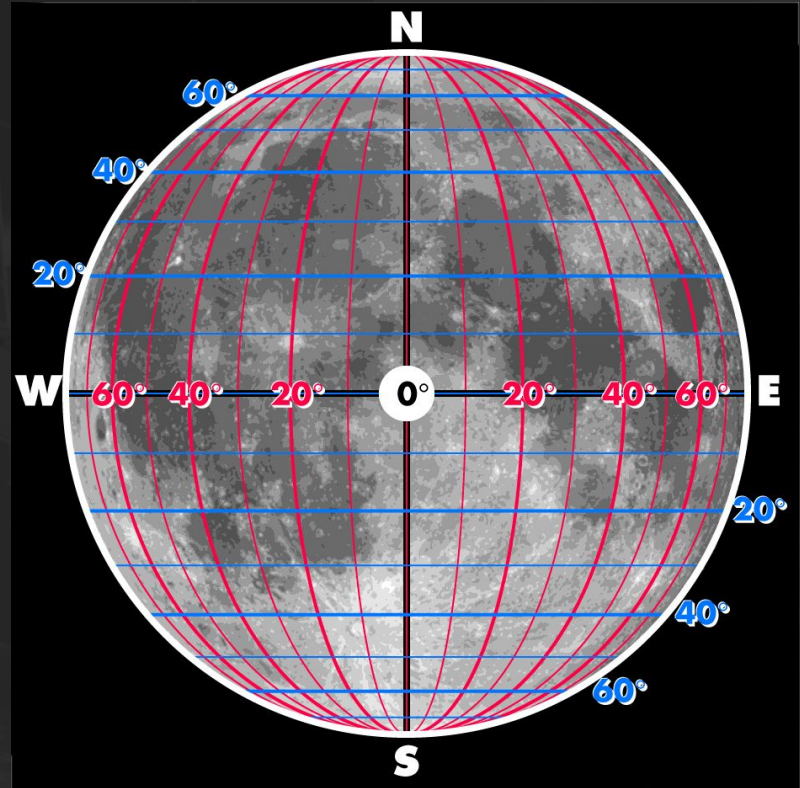

Concept of ILNSS - Data Communication

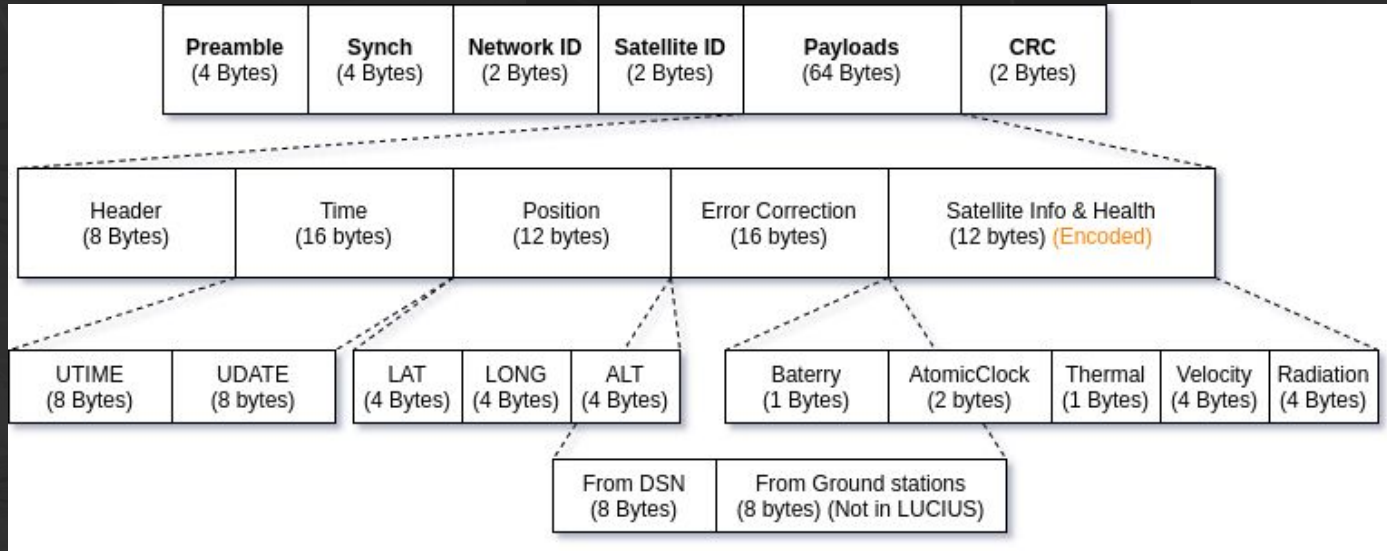

Packets of Datum will be sent from Satellites to ILNSS receivers as broadcast method in proximal frequency band for the planet atmosphere, full possible clock rate or as 10 MHz tick of atomic clock inside satellites.

Concept of ILNSS - Location determination

ILNSS works like GNSS on the Earth except it's on another sites like Lunar or Mars!!

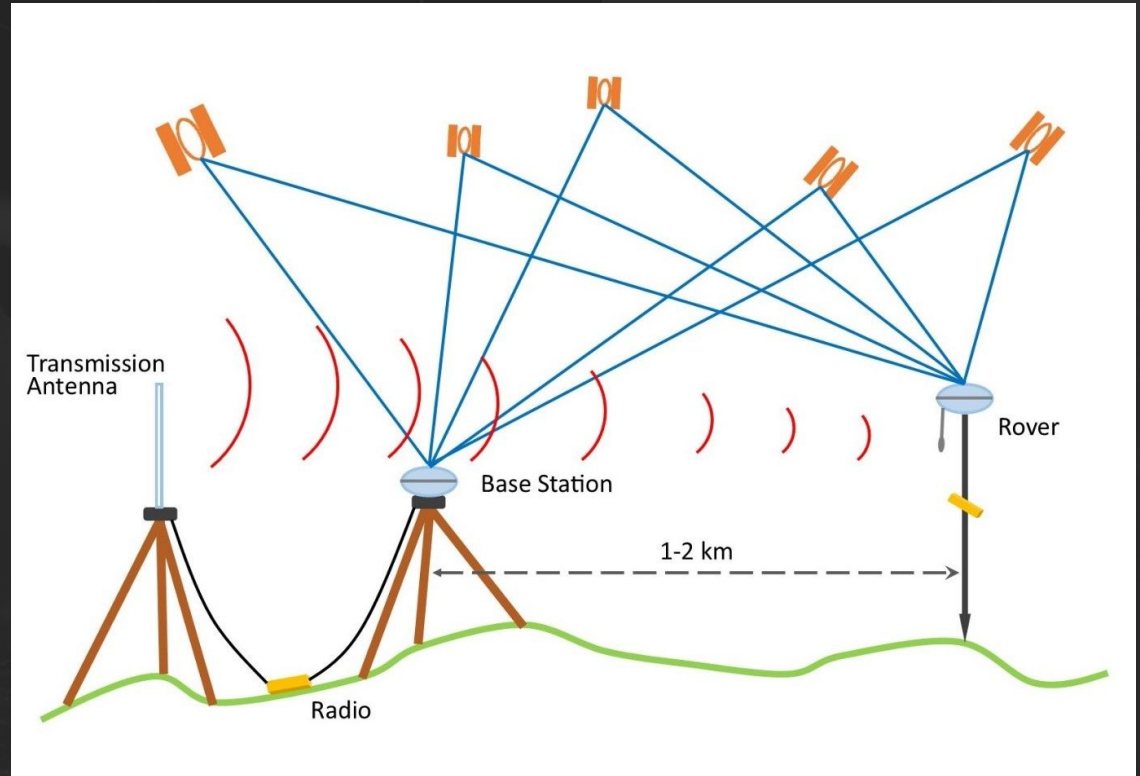

Concept of ILNSS - Verification system

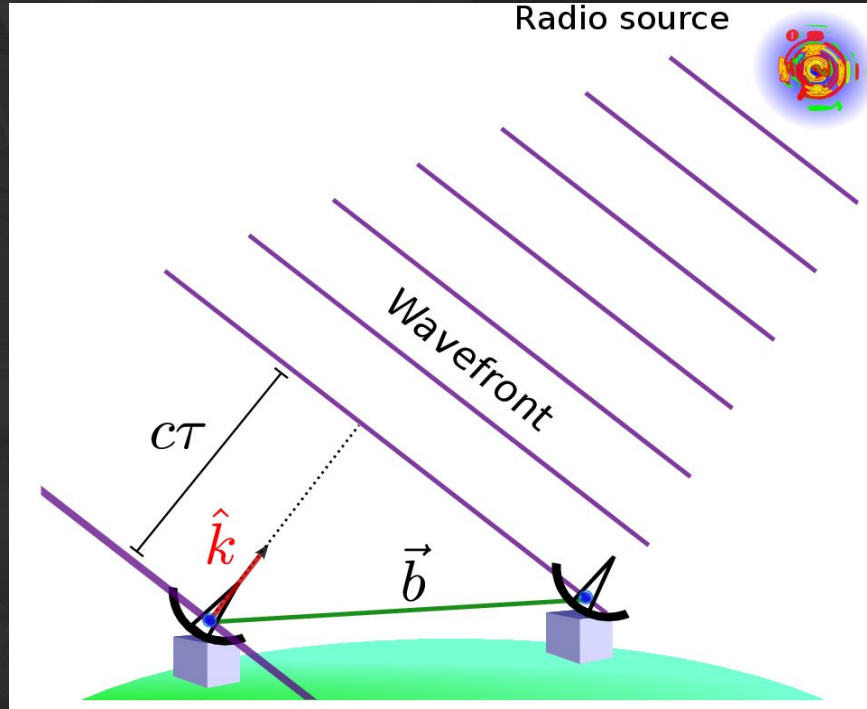

VLBI is the technique used in many scientific result in ILNSS mission we use it to define the celestial reference frame using satellites as radio source!!

Concept of ILNSS - Time Realization

Definition of system time

- The system time is internal, continuous navigation time scale, without leap second
- The basic unit is SI second
- The Largest unit used to start system time is one week, defined as 604800 second
- The system time is counted with the week number and the second of the week
- The zero point is 1 January 2000 (J2000)

Concept of ILNSS - Time Realization

Realization of the system time

- The system time is realized in a conception of composite clock
- The system time is maintained by a time and frequency system located at master control station

Time synchronization

- Station time and satellite time are synchronized via Two-way satellite time and frequency transfer (TWSTFT)

Concept of ILNSS - Time Realization

Accuracy

1-5 nanosecond

Precision

0.1 nanosecond

Stability (Averaging over one day)

$10^{-14} \sim 10^{-15}$

Assume there is no other effect other than the method of transfer.

Concept of ILNSS - Time Dilation

Due to Einstein theory of relativity, time is relative which can make high error to position measurement if didn't account for.
It can be cut to three parts...

- Time dilation due to earth gravitational field.
- Time dilation due to moon gravitational field.
- Time dilation due to satellite moving in space relative to outside observer.

Concept of ILNSS - Time Dilation

Time dilation due to earth gravitational field

In this frame time on satellite clock will tick faster relative to earth clock

Time dilation due to moon gravitational field

In this frame time on satellite clock will tick slower relative to earth clock

Time dilation due to velocity

From special theory of relativity moving clock will tick slower relative to non-moving observer

Total time delay calculate by sum all of Inverse Lorentz factor from all all frame of reference and multiply by day in second unit which have approximate value of 57.685 microsecond per day

Space segment

Operation **LUCIUS**
Target : Earth's Moon / Luna

Space Segment



LUCIUS

Satellite Design

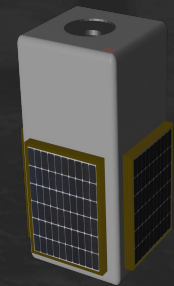

Space Segment - LUCIUS

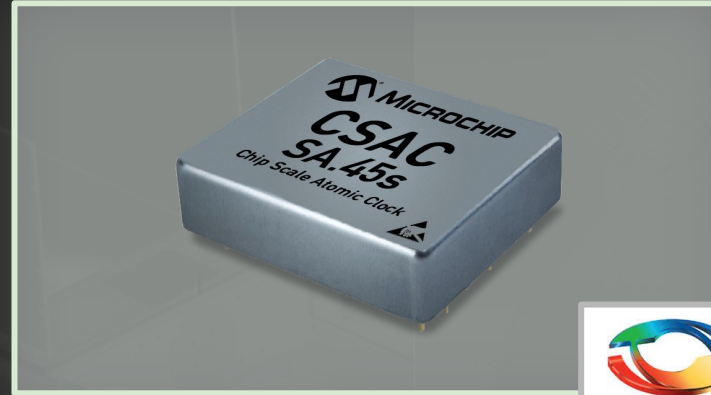
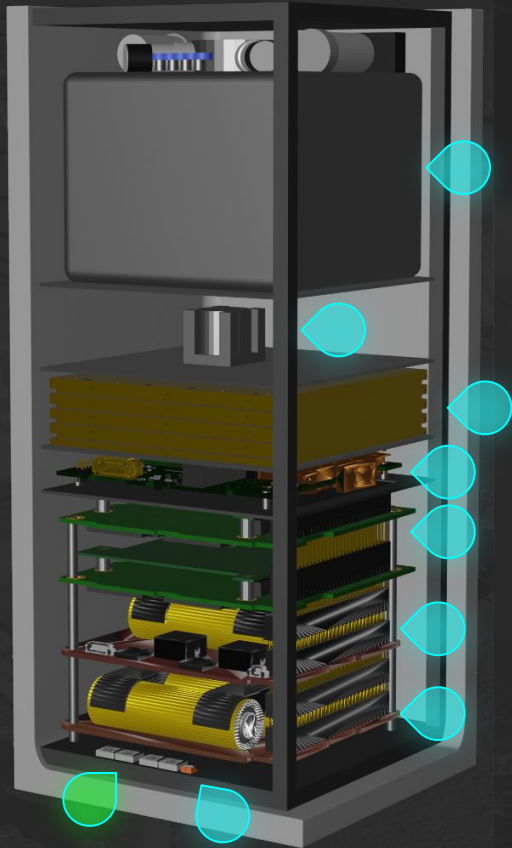

SA.45s Space CSAC

Space Segment - LUCIUS

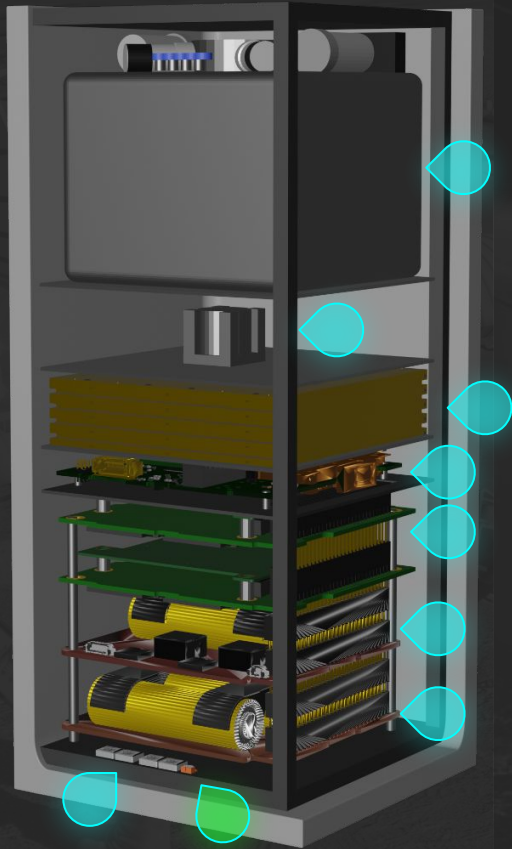

stim377h

Space Segment - LUCIUS

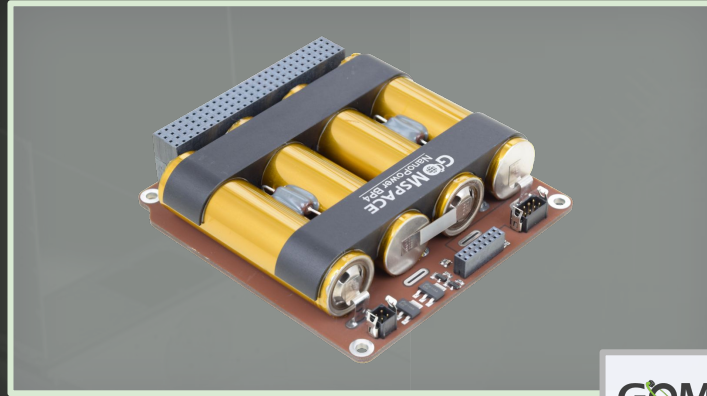
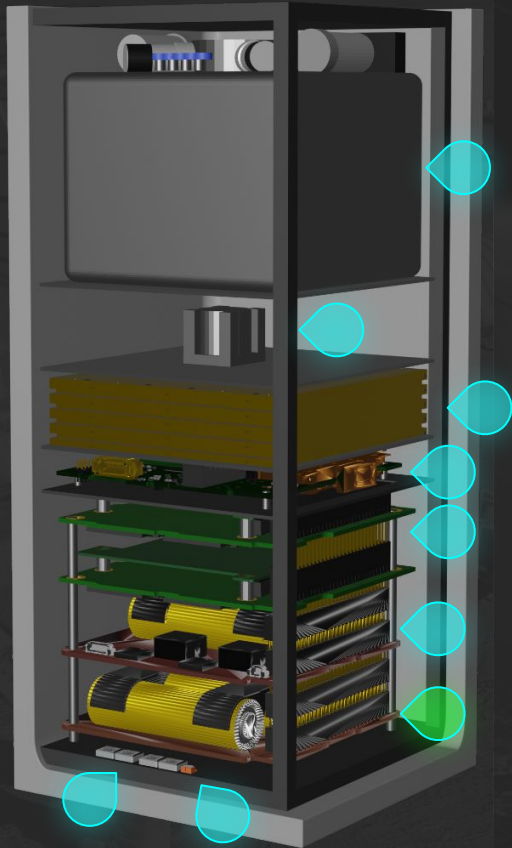

GOMSPACE

NanoPower BP4

Space Segment - LUCIUS

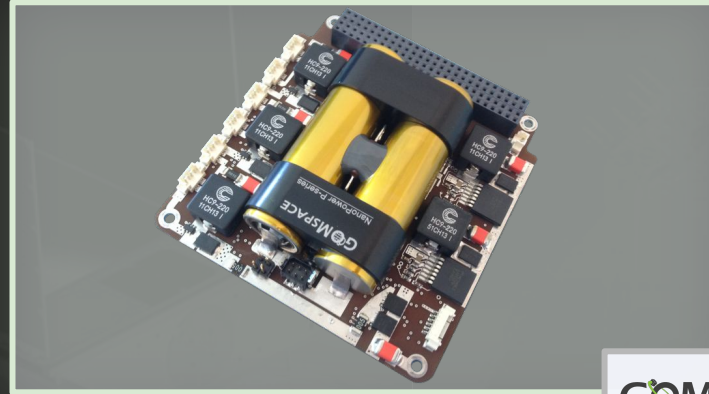
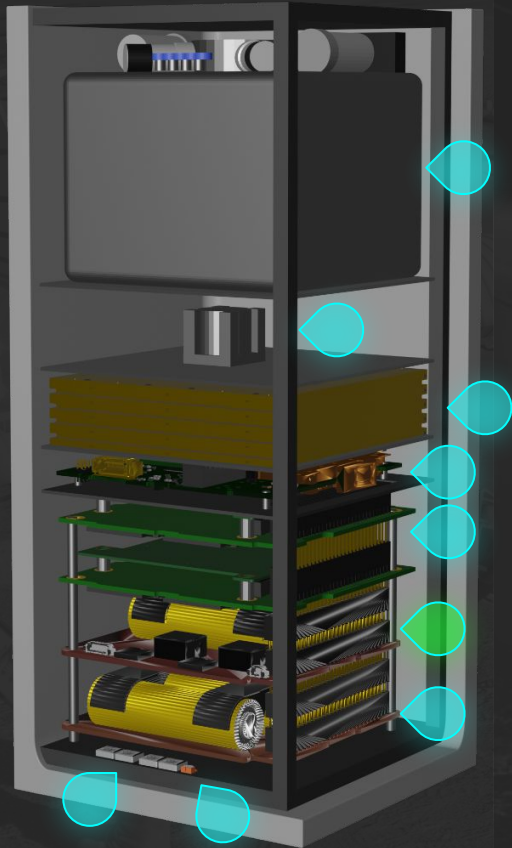

NanoPower P31u

Space Segment - LUCIUS

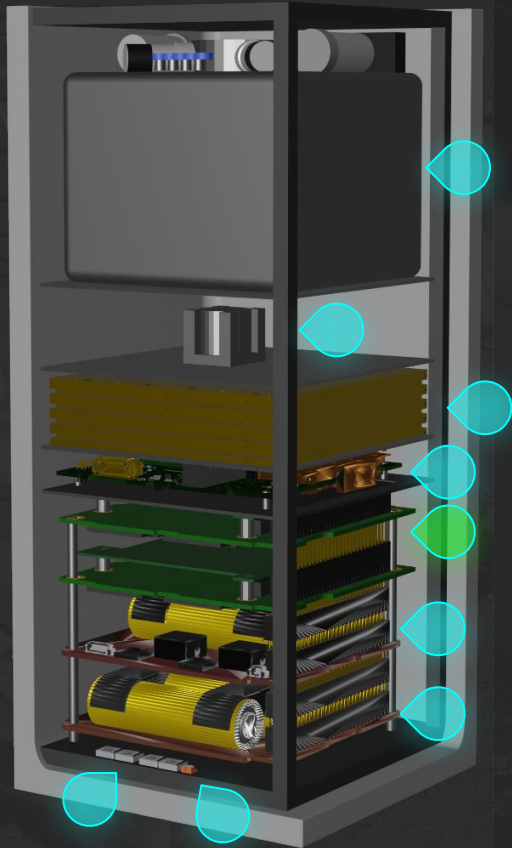

ISIS On board computer

Space Segment - LUCIUS

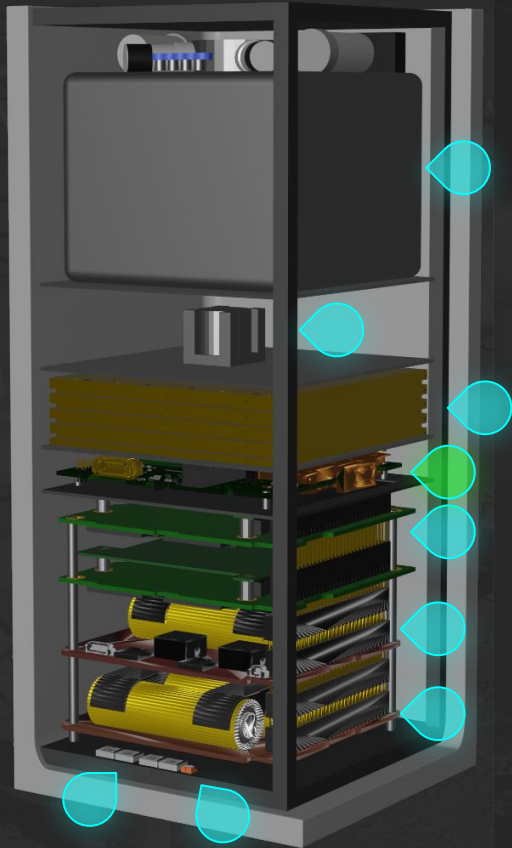

ISIS TXS S-Band Transmitter

Space Segment - LUCIUS

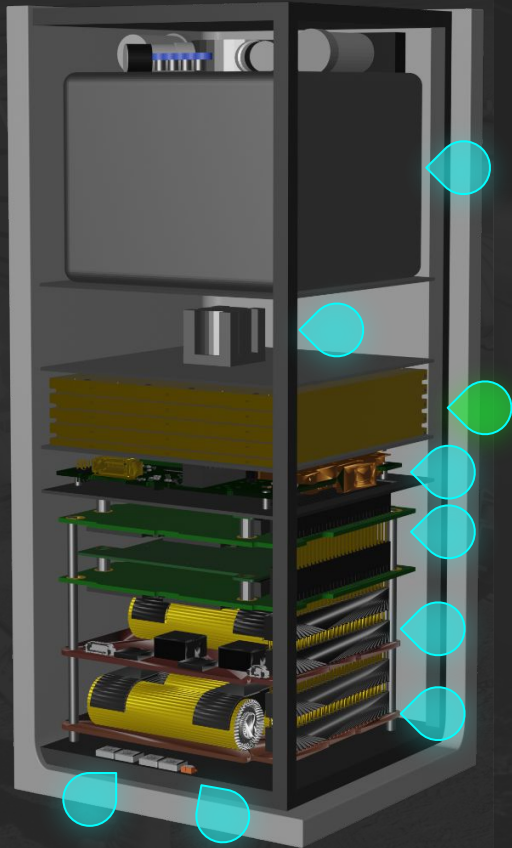

Iris V2.1 CubeSat Deep Space Transponder

Space Segment - LUCIUS

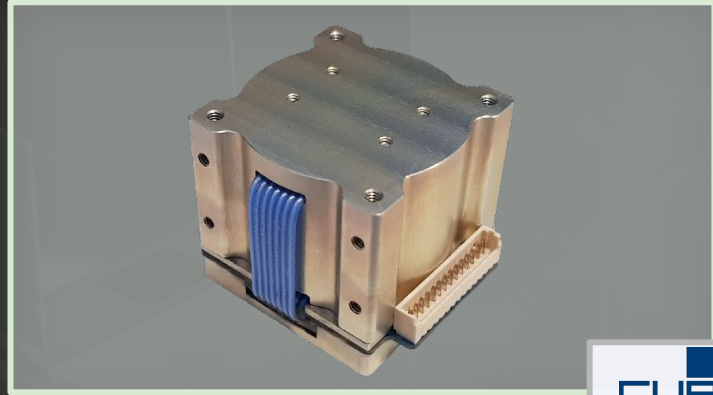
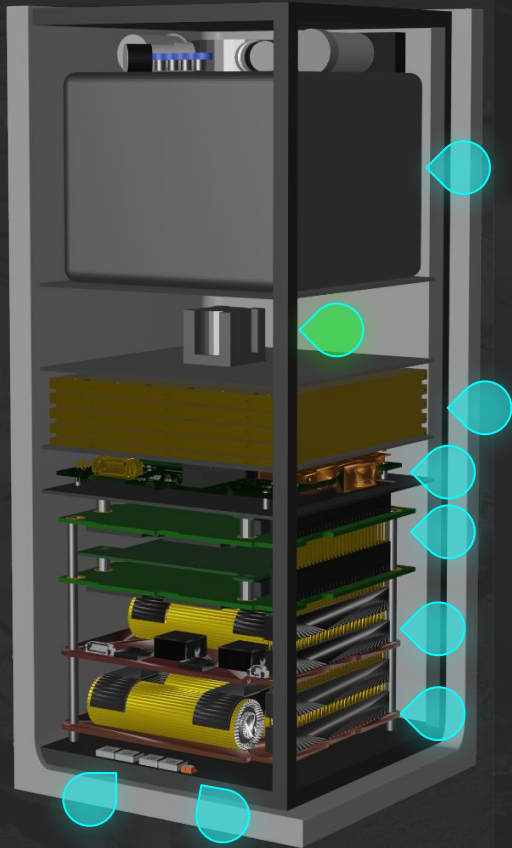

CubeWheel Small

Space Segment - LUCIUS

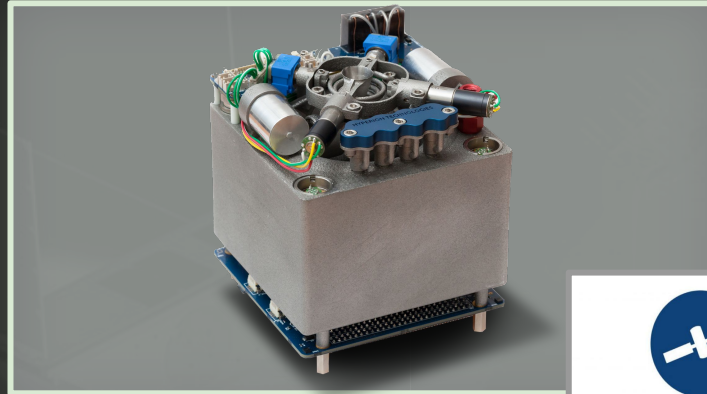
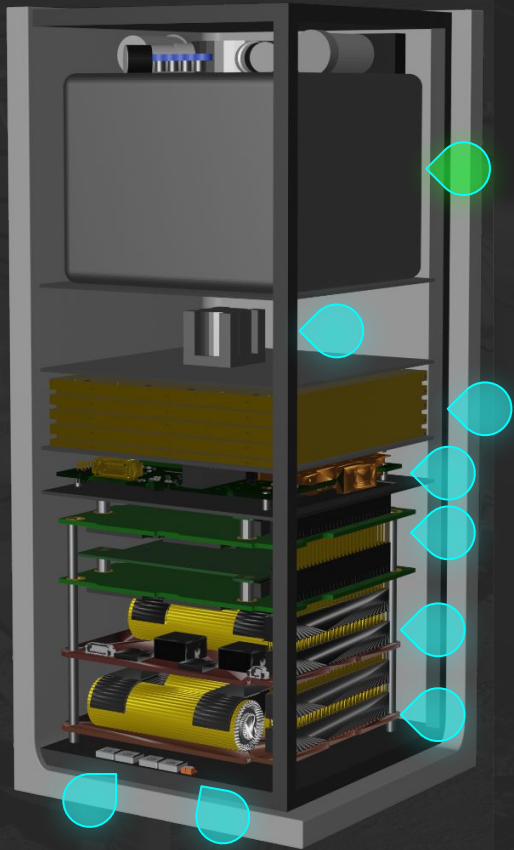

B.V. PM200

Space Segment - LUCIUS

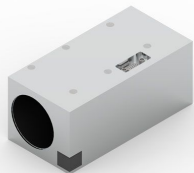

Arcsec Sagitta Star Tracker

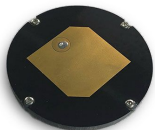

S-band Patch Antenna

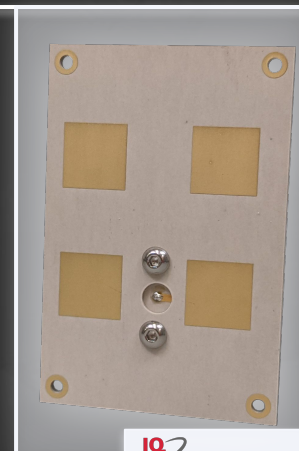
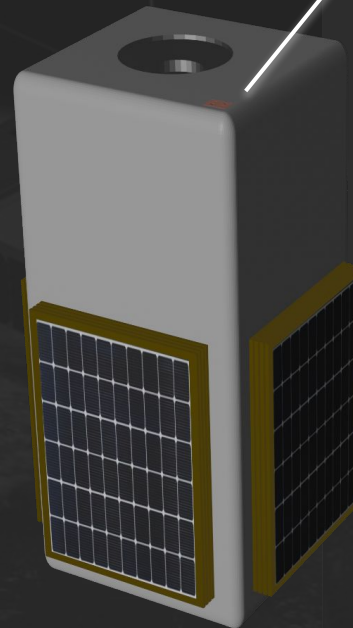
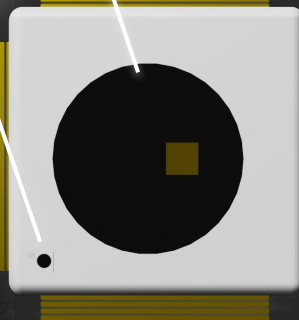

X-band Patch Antenna

Space Segment

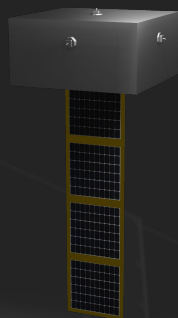
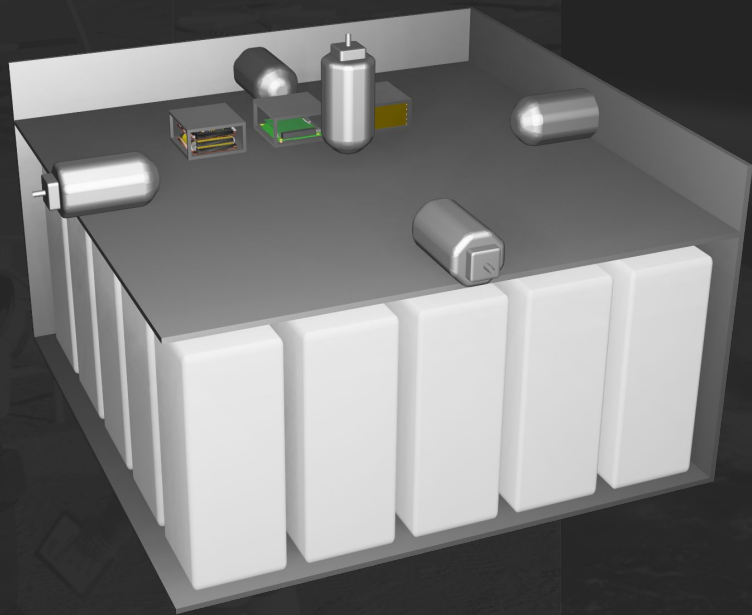

LUCIUS-D

Satellite Design

Space Segment - LUCIUS-D

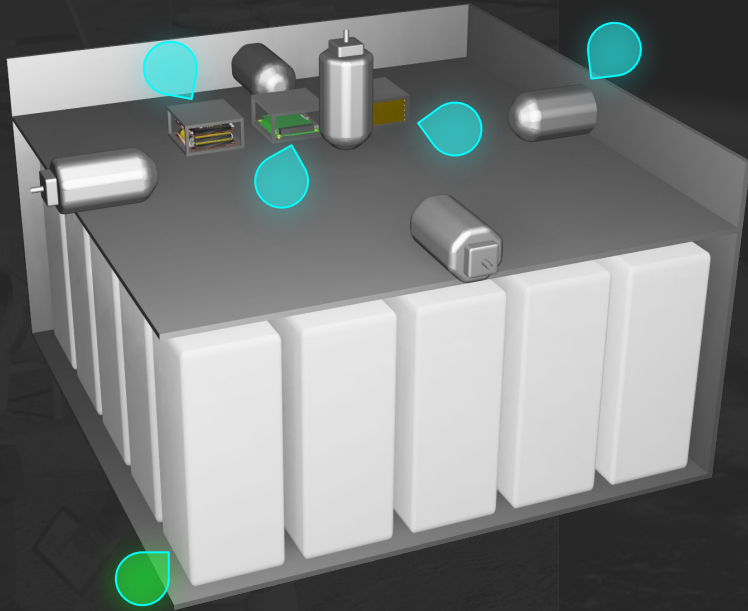

CubeSat Deployer

Space Segment - LUCIUS-D

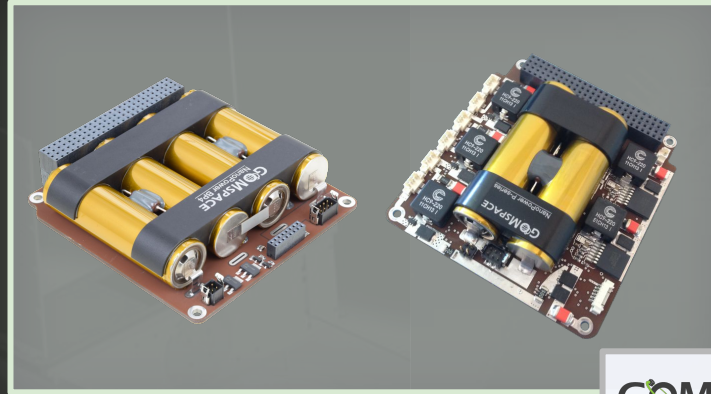
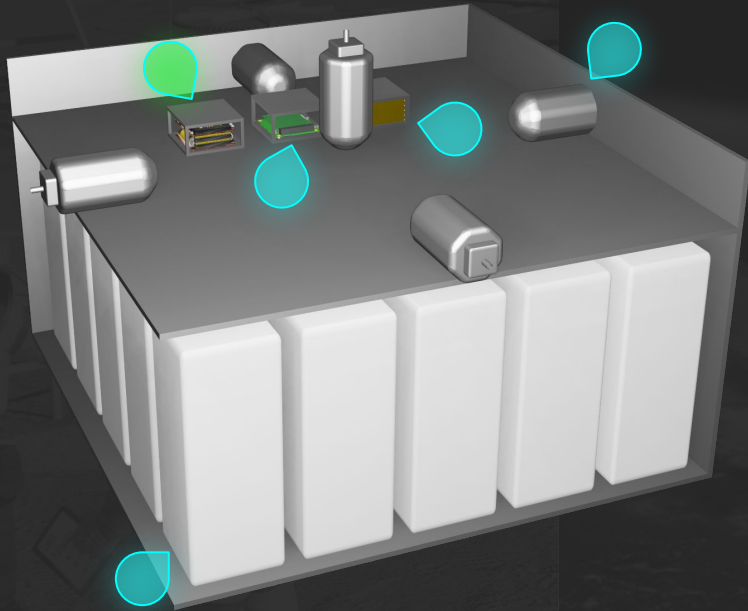

NanoPower B31U
NanoPower BP4

Space Segment - LUCIUS-D

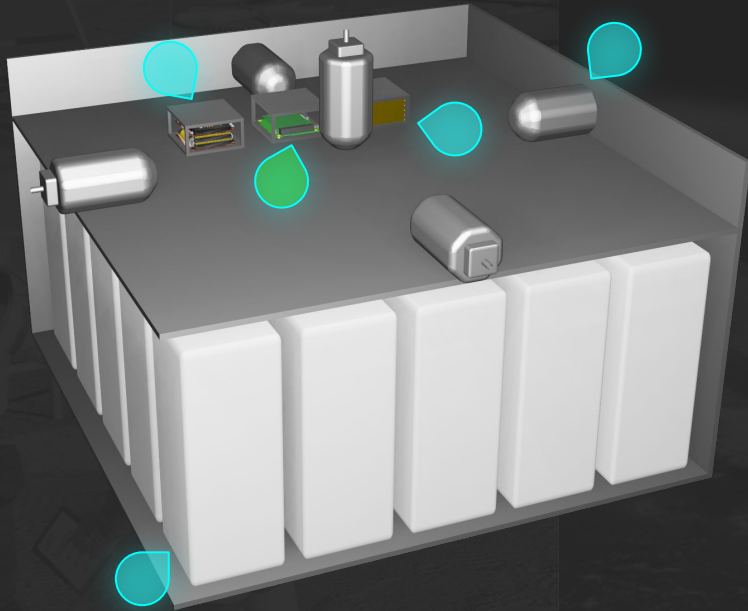

ISIS On board computer

Space Segment - LUCIUS-D

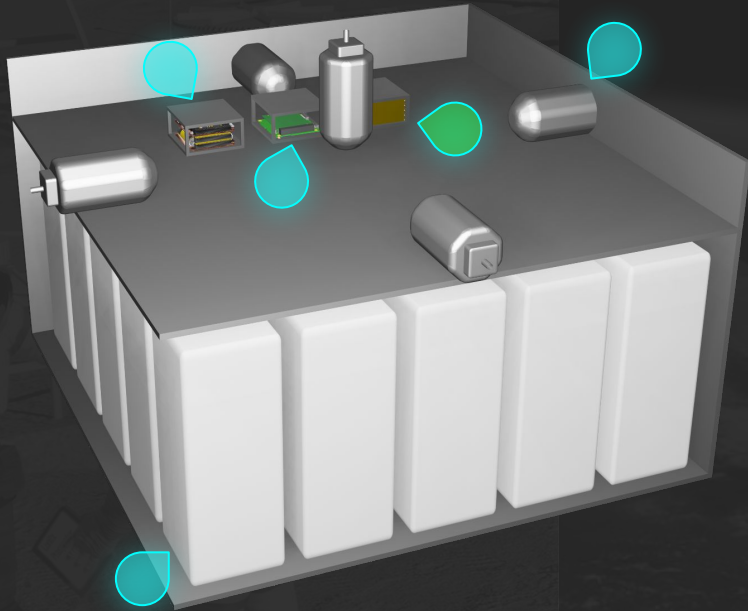

Iris V2.1 CubeSat Deep Space Transponder

Space Segment - LUCIUS-D

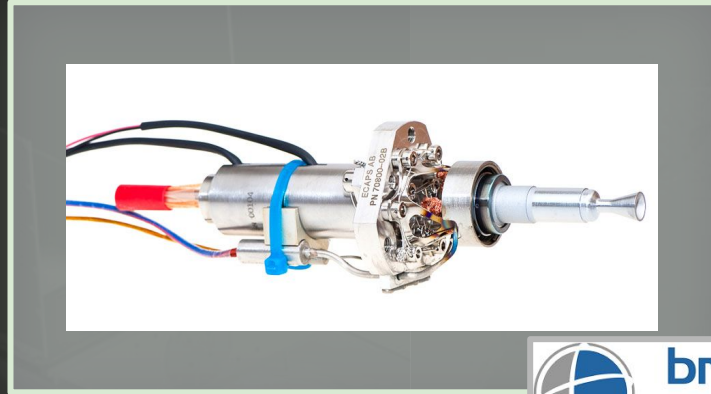
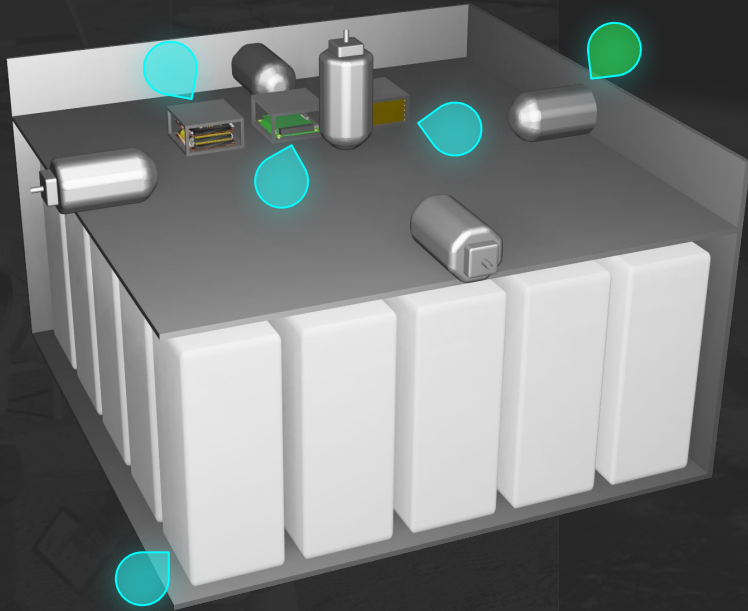

bradford ecaps In gp thruster

Space Segment - Link Budgets

Description	DSN Uplink	DSN Downlink	LUCIUS-D - Sat
Distance (km)	3.8463e+05	3.8804e+05	7.2996e+03
Elevation (deg)	64.2063	21.1103	-1.1569
Tx EIRP (dBW)	65	37	9
Polarization loss (dB)	3.0103	3.0103	3.0103
FSPL (dB)	221.2843	222.7232	176.6016
Total propagation losses (dB)	221.2843	222.7232	176.6016
Received isotropic power (dBW)	-162.2946	-191.7335	-172.6119
C/No (dB-Hz)	89.3045	59.8656	78.9873
C/N (dB)	21.5230	-14.1138	15.9770
Received Eb/No (dB)	19.3045	16.8553	19.9564
Margin (dB)	7.3045	4.8553	7.9564

Space Segment - Propulsion Analysis

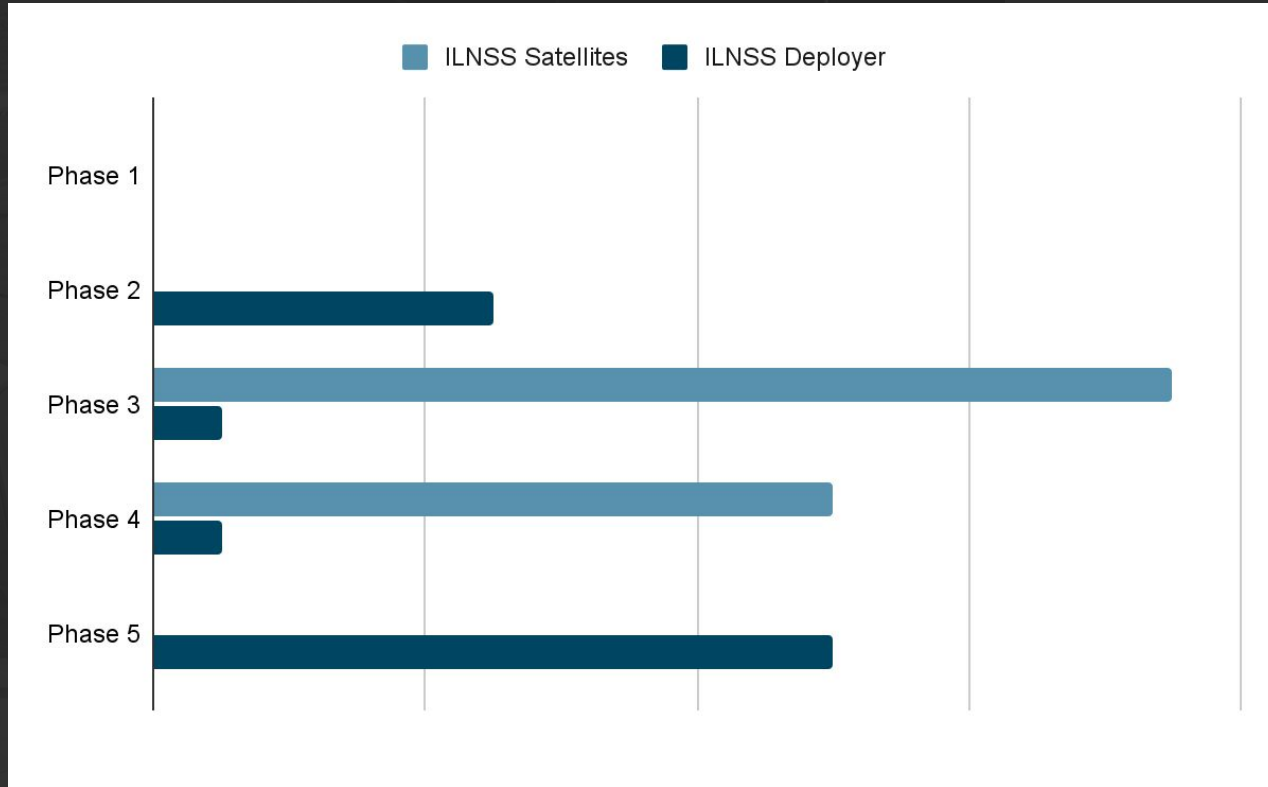

Space Segment - Energy Balance

	Initial Mode	Trajectory Mode	Mission Mode
Description	Only connected to DSN	Inclination Maneuver	ILNSS role operation
Power Consumption (mW)	36640	42640	65700
Power Regenerate (mW)	67200	67200	67200
Power Balance (mW)	30560	24560	1500
Energy balance trends (Wh)	+	+	+

Mission Analysis

Operation **LUCIUS**
Target : Earth's Moon / Luna

Mission Analysis - Risks

VLBI TECHNIQUE FAILED - MEDIUM

VLBI on satellites still experiment for defining celestial reference frame coordinate system.

LESS ACCURACY WITHOUT VERIFICATION - LOW

On gas planet we can't land anything on the surface, ILNSS maybe works in absolute location service instead.

ELECTRONICS FAILED - LOW

Electric systems on 24/7 Earth hours not guaranteed to work for ILNSS project in case of total ΔE Balance.

Mission Analysis - Budgets

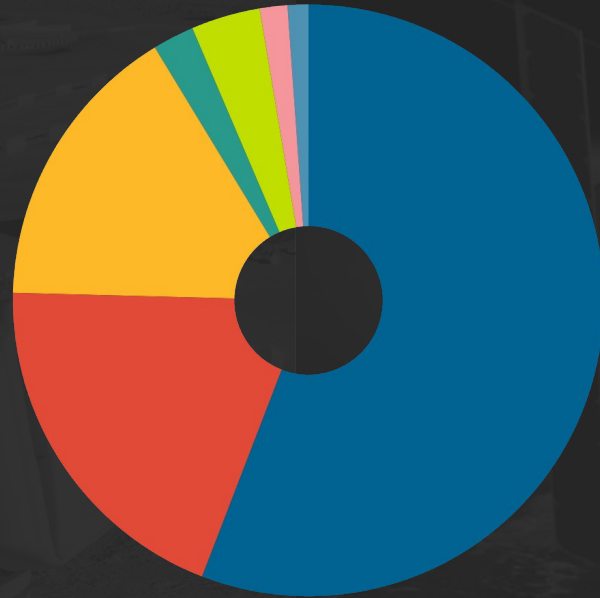

● Navigation ● Communication ● Payload ● Deployer ● Testing ● Analysis ● Maintenance

LUCIUS Mission costs...
< 2 million \$
For entire Lunar nav system

Mission Analysis - Implementation Plan

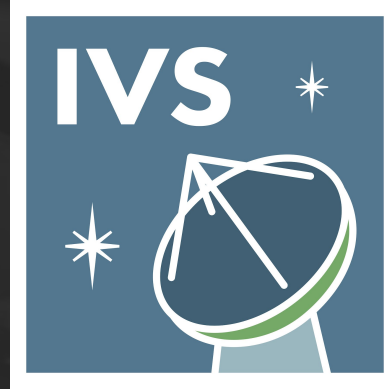

Q&A

ILNSS : Network For Position On Lunar Surface And Interplanetary Prototype