

ICE Cubes Facility to Experiment Cube IRD

---

## ICE Cubes

**Title** : ICE Cubes Facility to Experiment Cube IRD

**Abstract** : This document provides a comprehensive interface definition between the ICE Cubes Facility (ICF) and the Experiment Cube to the ICE Cubes service customer (i.e. Experiment Cube development responsible).

This IRD is to be complemented by the guidelines ICU-SA-TN-011 [RD1] (TBW).

Both documents are updated at regular intervals. Before proceeding, the reader shall ensure to be in possession of the latest versions by checking on our website:



<http://icecubesservice.com/>

**Grant Agreement N°** : 666815

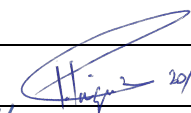

International Commercial  
Experiments Service

ICE Cubes Facility to Experiment Cube IRD

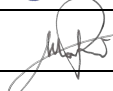
DOCUMENT APPROVAL SHEET			
	Name	Company	Signature and Date
Prepared by:	ICE Cubes Team	Space Applications Services	
Checked by:	T. Peignier	Space Applications Services	 20/04/2018
PA Checked by:	L. Tazi	Space Applications Services	 20-Apr-2018
Approved by:	M. Ricci	Space Applications Services	 20/04/2018

Space Applications Services NV/SA  
 Leuvensesteenweg 325  
 1932 Sint-Stevens-Woluwe, Belgium

Tel: +32-(0)2-721.54.84  
 Fax: +32-(0)2-721.54.44  
 Web: www.spaceapplications.com

*This document is the property of  
 Space Applications Services NV/SA.  
 All rights reserved.*

**ICE Cubes Facility to Experiment Cube IRD**

<b>DOCUMENT CHANGE RECORD</b>				
<b>Version</b>	<b>Date</b>	<b>Author</b>	<b>Changed Sections / Pages</b>	<b>Reason for Change / RID No</b>
1.0.0	29-Jul-2016	ICE Cubes Team		Initial release
1.1.3	30-Jan-2017	ICE Cubes Team	All	Draft release for PDR
1.2.0	16-Mar-2018	ICE Cubes Team	§1.3, §3.4.1, §3.5.1, §3.6.1, §3.6.3, §3.6.5, §3.6.7, §3.8.1, §3.8.10, Appendix A, Appendix C, Appendix D	Update of RDs; Electrical interface update; Addition of clarifications about communications between UHBs and Experiment Cubes, and about antivirus; Addition of §3.6.7; Deletion of §4.2.3.7 to §4.2.3.9; Addition of Appendix A and Appendix D; Update of Appendix C; Editorial corrections throughout the document
1.2.1	20-Apr-2018	ICE Cubes Team	§3.4.1, §3.5.1.3	Figure 13 minor update; Addition of capacitive coupling requirement

ICE Cubes Facility to Experiment Cube IRD

**Table of Contents**

<b>1</b>	<b>Introduction .....</b>	<b>8</b>
1.1	Purpose and Scope .....	8
1.2	Applicable Documents.....	8
1.3	Reference Documents.....	8
1.4	Acronyms.....	9
<b>2</b>	<b>ICE Cubes Flight Segment Overview .....</b>	<b>11</b>
2.1	The ICE Cubes Facility (ICF) .....	11
2.2	The Framework .....	12
2.3	“Internal” Experiment Cubes .....	13
2.4	“External” Experiment Cubes and Other Payloads .....	14
2.5	Thermal Cooling .....	15
<b>3</b>	<b>Experiment Cube Flight Interface Requirements.....</b>	<b>16</b>
3.1	Mechanical Requirements.....	16
3.1.1	Experiment Cube Connector .....	16
3.1.2	Outer Surfaces.....	17
3.1.3	Vents & Fins .....	17
3.1.4	Standard Form Factors.....	17
3.1.5	Dimensions & Tolerances.....	18
3.1.6	Sharp Edges .....	18
3.1.7	Audible Noise.....	19
3.1.7.1	Continuous Noise Limits .....	19
3.1.7.2	Intermittent Noise Limits .....	19
3.1.7.3	Audible Noise Limits Verification .....	19
3.1.8	Microgravity Disturbances .....	19
3.2	Structural and Environmental Interface Requirements .....	19
3.2.1	Environmental Conditions.....	19
3.2.1.1	Transport, Storage and Launch in Unpowered Conditions .....	19
3.2.1.2	Thermal Environment inside the ICE Cubes Facility .....	20
3.2.2	Launch & Landing Loads.....	20
3.2.3	Random Vibration Loads .....	21
3.2.4	Shock Loads .....	21
3.3	Thermal Requirements.....	21
3.3.1	Temperature Control .....	21
3.3.2	Touch Temperature .....	21
3.3.3	Thermal Sensor .....	21
3.3.4	Condensation Prevention .....	21

**ICE Cubes Facility to Experiment Cube IRD**

---

3.4	Electrical Interface Requirements .....	22
3.4.1	DB13W3 Connector Proprietary Wiring.....	22
3.4.2	Power.....	22
3.4.3	Unexpected Power Loss.....	23
3.5	Electromagnetic Compatibility (EMC) Requirements .....	23
3.5.1	Grounding, Bonding & Isolation.....	23
3.5.1.1	Grounding (i.e. Ground Return).....	23
3.5.1.2	Bonding (i.e. Chassis Ground) .....	23
3.5.1.3	Isolation .....	23
3.5.2	Electromagnetic Interference.....	24
3.5.2.1	Radiated Emissions .....	24
3.5.2.2	Conducted Emissions .....	24
3.5.2.3	Radiated Susceptibility .....	24
3.5.2.4	Conducted Susceptibility .....	25
3.5.2.5	Electromagnetic Interferences Verification.....	26
3.5.3	Electrostatic Discharge (ESD).....	26
3.5.4	DC Magnetic Fields .....	26
3.6	Data & Communication Interface Requirements.....	26
3.6.1	Experiment Cube IP Communication .....	26
3.6.2	Experiment Cubes Data Synchronization Service.....	27
3.6.3	Telemetry (TM) & Telecommand (TC) .....	28
3.6.4	Experiment Cube Download of Data .....	28
3.6.5	Experiment Cube Security.....	28
3.6.6	Gigabit Ethernet Interface.....	28
3.6.7	Intentional Transmitters and Receivers.....	28
3.7	Materials Requirements .....	29
3.7.1	Declared Materials List.....	29
3.7.2	Forbidden Materials and Components .....	29
3.7.3	Surface Treatments & Protective Coatings .....	29
3.7.4	Flammability.....	29
3.7.5	Offgassing.....	29
3.7.6	Fasteners Locking .....	29
3.8	Safety Requirements.....	30
3.8.1	Collection of Safety-Related Data .....	30
3.8.2	Non-Conformity with Requirements .....	30
3.8.3	Containment .....	30
3.8.4	Volatile Organic Compound.....	30

**ICE Cubes Facility to Experiment Cube IRD**

---

3.8.5	Shatterable Materials Release .....	30
3.8.6	Lasers .....	30
3.8.7	Batteries.....	30
3.8.8	Pyrotechnics .....	30
3.8.9	Smoke & Fire Detection.....	30
3.8.10	Flight Readiness Certification.....	30
3.9	Human Factor Interface Requirements .....	31
3.9.1	Astronaut Interaction .....	31
3.9.2	Identification & Marking .....	31
3.10	Reliability Requirements.....	31
<b>4</b>	<b>Experiment Cube Ground Interface Requirements .....</b>	<b>32</b>
4.1	Hardware Interface.....	32
4.2	Software Interface .....	32
4.2.1	UHB to ICMCC Interface Overview .....	32
4.2.2	Mandatory Software Interface Requirements.....	33
4.2.2.1	Software Host .....	33
4.2.2.2	Connection to the ICMCC.....	33
4.2.2.3	Two-Factor Authentication.....	33
4.2.2.4	Security, Split Tunnelling .....	33
4.2.2.5	System Time Synchronisation .....	34
4.2.3	Optional Software Interface Requirements .....	34
4.2.3.1	Data Synchronization Service Downlink.....	34
4.2.3.2	Data Synchronization Service Uplink .....	34
4.2.3.3	Private IP Address.....	34
4.2.3.4	Direct TCP and UDP Communication .....	34
4.2.3.5	TCP and UDP Protocol.....	34
4.2.3.6	UDP Connection.....	34
4.3	Experiment Cube Unit-to-System Testing.....	34
<b>Appendix A</b>	<b>Verification Matrix .....</b>	<b>35</b>
<b>Appendix B</b>	<b>Drawings .....</b>	<b>38</b>
<b>Appendix C</b>	<b>Random Vibration Loads.....</b>	<b>40</b>
<b>Appendix D</b>	<b>Typical Timeline and Required Documents.....</b>	<b>41</b>

**ICE Cubes Facility to Experiment Cube IRD**

---

**List of Figures**

Figure 1 ICE Cubes Facility closed and open views ..... 11  
 Figure 2 Framework features ..... 12  
 Figure 3 Framework with one 2Ux2U Experiment Cube ..... 13  
 Figure 4 1U Experiment Cube with protruding male DB13W3P connector ..... 13  
 Figure 5 Accommodation of wired external payload (concept) ..... 14  
 Figure 6 Schematics of the forced air cooling inside the ICF Container ..... 15  
 Figure 7 DB13W3P male plug (Cube side) ..... 16  
 Figure 8 Protrusion of the DB13W3P male connector from the Cube wall ..... 16  
 Figure 9 Proper positioning of the DB13W3P male connector on a 1U Cube (dimensions in mm)..... 17  
 Figure 10 Experiment Cube standard form factors ..... 18  
 Figure 11 DB13W3S schematic (receptacle, Framework side) ..... 22  
 Figure 12 DB13W3P schematic (plug, Cube side)..... 22  
 Figure 13 DB13W3 pin assignment..... 22  
 Figure 14 Narrowband radiated emission limits ..... 24  
 Figure 15 Radiated susceptibility E-field limit..... 25  
 Figure 16 Transient pulse definition ..... 25  
 Figure 17 ICE Cubes communications (concept)..... 32

**List of Tables**

Table 1 Experiment Cubes standard external dimensions..... 18  
 Table 2 Continuous noise limits ..... 19  
 Table 3 Environmental conditions (unpowered) ..... 20  
 Table 4 Launch and landing load factors envelope..... 21  
 Table 5 ICE Cubes Internet protocols ..... 27  
 Table 6 LOS impact on communications between a UHB and its Experiment Cube..... 33  
 Table 7 Cut-out dimensions for front and rear mounting methods for DB13W3P connector (mm). .... 38  
 Table 8 Random vibration environment attenuated by 76mm of bubblewrap..... 40  
 Table 9 Random vibration test profile enveloping Space X Dragon and Orbital Cygnus ..... 40  
 Table 10 Experiment Cube Timeline ..... 41  
 Table 11 Documents to be produced by the customer ..... 41

**ICE Cubes Facility to Experiment Cube IRD**

---

# **1 Introduction**

## **1.1 Purpose and Scope**

This Interface Requirements Document (IRD) defines the requirements on external interfaces between the ICE Cubes Facility (ICF) and the Experiment Cube to be accommodated inside it when using the ICE Cubes service. In addition, this IRD provides requirements for design and testing of the Experiment Cube, and software interface requirements necessary for the customer to communicate from ground with his/her Experiment Cube in orbit.

This IRD is to be complemented by the guidelines ICU-SA-TN-011 [RD1] (TBW).

Both documents are updated at regular intervals. Before proceeding, the reader shall ensure to be in possession of the latest versions by checking on our website: <http://icecubesservice.com/>

As the individual Experiment Cube is developed, appropriate sections of the IRD will serve as the basis for establishing a specific Experiment Cube Interface Control Document (ICD) to be agreed with the ICE Cubes service provider, i.e. Space Applications Services. The ICD shall take over precedence over the IRD for the Experiment Cube for which an ICD exists.

The sections on Experiment Cube requirements take into account the relevant documents listed in §1.3 and ICU-SA-RQ-007 [AD1], and incorporate the technical requirements of the latter documents to the maximum extent compatible with the technical limitations of the ICF and the programmatic constraints of the ICF development programme.

## **1.2 Applicable Documents**

The following document establishes requirements that are applicable to the Experiment Cubes.

AD1 Space Applications Services – ICE Cubes TM/TC Protocol, ICU-SA-RQ-007, Version 0.1.0, 30-Jan-2017

## **1.3 Reference Documents**

The following documents provide information useful in the design, development and verification of the Experiment Cube. The requirements directly applicable to the Experiment Cube have been already reported in this IRD, and as such the documents below do not need to be considered as applicable.

- RD1 Space Applications Services – Guidelines for Experiment Cube Design and Development, ICU-SA-TN-011, latest version
- RD2 OHB System AG – Science Module Interface Requirements Document (SMIRD) for the European Physiology Model (EPM), EPM-OHB-RQ-0001, Issue 4, 30-Apr-2010 (+ relevant IRNs)
- RD3 Astrium – Columbus Pressurized Payloads Interface Requirements Document, COL-RIBRE-SPE-0164, Issue 2A, 15-Nov-2013 (+ relevant IRNs)
- RD4 NASA – ISS Pressurized Volume Hardware Common Interface Requirements Document: International Space Station Program, SSP 50835, Rev. D, April 2013 (+ associated PIRNs)
- RD5 Space X – C3-1 Dragon Interface Definition Document, SPX-00001047, Version 21, 14-Aug-2014
- RD6 Astrium – Columbus Payload Engineering Integration Requirements, ESO-IT-TN-0173, Issue 4, 20-Mar-2017



**ICE Cubes Facility to Experiment Cube IRD**

---

- RD7 ESA – Security Requirements for LAN Connected Payloads, ESA-ISS-COL-SEC-RS-0002, Issue 1, 14-Oct-2014
- RD8 ISO – General tolerances -- Part 1: Tolerances for linear and angular dimensions without individual tolerance indications, ISO 2768-1:1989, 02-Nov-1989
- RD9 ISO – General tolerances -- Part 2: Geometrical tolerances for features without individual tolerance indications, ISO 2768-2:1989, 02-Nov-1989
- RD10 ISO – Space systems -- Safety and compatibility of materials -- Part 1: Determination of upward flammability of materials, ISO 14624-1:2003, 01-Jun-2003
- RD11 ISO – Space systems -- Safety and compatibility of materials -- Part 2: Determination of flammability of electrical-wire insulation and accessory materials, ISO 14624-2:2003, 01-Jun-2003
- RD12 Underwriters Laboratories – Standard for Tests for Flammability of Plastic Materials for Parts in Devices and Appliances, UL 94, 6<sup>th</sup> edition, 28-Mar-2013
- RD13 IETF – Network Time Protocol Version 4: Protocol and Algorithms Specification, RFC 5905, Jun-2010
- RD14 IETF – Transmission Control Protocol, RFC 793, Sep-1981
- RD15 IETF – User Datagram Protocol, RFC 768, 28-Aug-1980

**1.4 Acronyms**

AD	Applicable Document
AOS	Acquisition of Signal
CCSDS	Consultative Committee for Space Data Systems
CD	Cube Detection
CFDP	CCSDS File Delivery Protocol
COTS	Commercial Off The Shelf
CTB	Cargo Transfer Bag
DC	Direct Current
DDS	Data Distribution Service
DML	Declared Materials List
EDR	European Drawer Rack
EMC	Electromagnetic Compatibility
EPM	European Physiology Module
ESA	European Space Agency
ESD	Electrostatic Discharge
FSR	Flight Safety Review
FTP	File Transfer Protocol
GND	Ground
GRE	Generic Routing Encapsulation
HK	Housekeeping
H&S	Health and Status
HTTP	Hypertext Transfer Protocol
HTTPS	HTTP Secure
HTV	H-II Transfer Vehicle
ICD	Interface Control Document
ICE Cubes	International Commercial Experiment Cubes
ICF	ICE Cubes Facility
ICMCC	ICE Cubes Mission Control Centre
ICMP	Internet Control Message Protocol

**ICE Cubes Facility to Experiment Cube IRD**

---

IETF	Internet Engineering Task Force
IP	Internet Protocol
IRD	Interface Requirements Document
IRN	Interface Revision Notice
ISO	International Organization for Standardization
ISS	International Space Station
LAN	Local Area Network
LED	Light-Emitting Diode
LOS	Loss of Signal
N/A	Not Applicable
NASA	National Aeronautics and Space Administration
NLT	Not Later Than
NTP	Network Time Protocol
PDR	Preliminary Design Review
PIRN	Preliminary Interface Revision Notice
PKI	Public Key Infrastructure
RD	Reference Document
RDT	Real Data Transport
RFB	Remote Framebuffer
RID	Review Item Discrepancy
RTCP	RTP Control Protocol
RTP	Real-time Transport Protocol
RTPS	Real Time Publish Subscribe
RTSP	Real Time Streaming Protocol
SFTP	SSH File Transfer Protocol
SPL	Sound Pressure Level
SSD	Solid State Drive
SSH	Secure Shell
SSL	Secure Sockets Layer
TBC	To Be Confirmed
TBD	To Be Determined
TBW	To Be Written
TC	Telecommand
TCP	Transmission Control Protocol
TIM	Technical Interchange Meeting
TLS	Transport Layer Security
TM	Telemetry
U	Unit (= 10 x 10 x 10 cm)
UDP	User Datagram Protocol
UHB	User Home Base
USB	Universal Serial Bus
VNC	Virtual Network Computing
VPN	Virtual Private Network
WAP	Wireless Access Point
WLAN	Wireless Local Area Network
XLS	Microsoft Excel Spreadsheet File Format
XML	Extensible Markup Language
XTCE	XML Telemetric and Command Exchange

## ICE Cubes Facility to Experiment Cube IRD

## 2 ICE Cubes Flight Segment Overview

This section provides an overview of the ICE Cubes Facility (ICF). Detailed information and interface requirements are provided in section 3 and section 4.

### 2.1 The ICE Cubes Facility (ICF)

The main characteristics in terms of physical conceptual configuration are briefly highlighted in the following.

The ICE Cubes Facility (ICF) is composed of:

- The **Framework**, accommodating up to 20 Experiment Cubes, and providing power and data/commands connectivity.
- The structural **Container**, to be installed and mechanically fastened inside the hosting rack on board Columbus.
- **External harnesses and hoses** (if any), as necessary, to interface the Columbus rack electrical jumpers and thermal control parts.
- Removable **mass memory storage devices**, namely the Solid State Drives (SSDs) and USB flash drives necessary to host the operational software and to physically download the scientific data.

The **Experiment Cubes** are standardized plug-and-play research modules (1U = 10cmx10cmx10cm) or modular combinations of that basic size.

Views of the ICF with the Framework and the Experiment Cubes are shown in Figure 1.

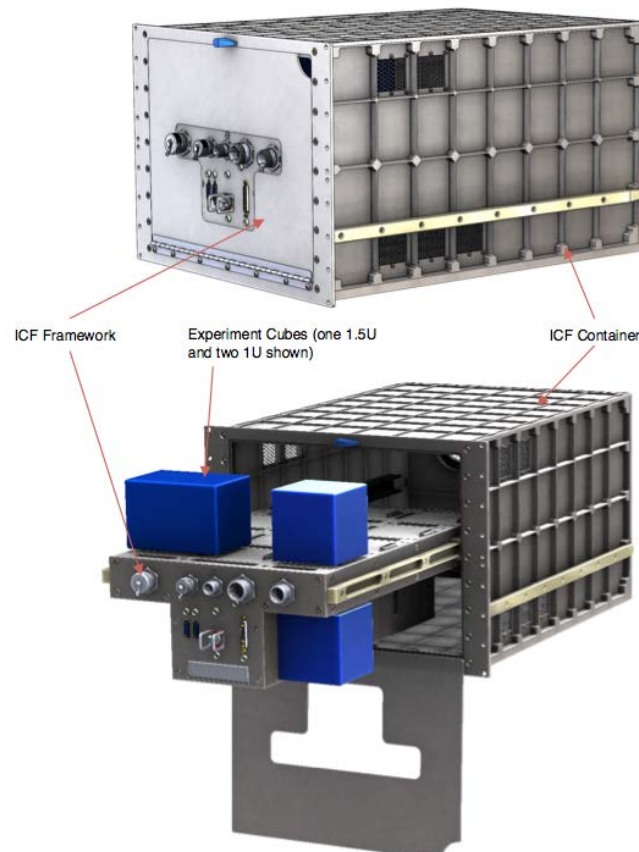

Figure 1 ICE Cubes Facility closed and open views

ICE Cubes Facility to Experiment Cube IRD

2.2 The Framework

The Framework (Figure 2) is the central unit that accommodates each Experiment Cube and offers services such as power, connectivity and data storage.

It offers:

- Up to 20 active locations (power + gigabit Ethernet) for the accommodation and management of “internal” Experiment Cubes, each location is equipped with one DB13W3S female receptacle.
- 1 active location (in the front) for the accommodation/interfacing of an Experiment Cube located externally to the ICF and connected via a cable (see Fig. TBD)
- 1 Wireless Access Point (WAP) for the management of Experiment Cubes hosted in Columbus and connected via a private Wireless Local Area Network (WLAN) generated by the ICF.
- 2 USB 3.0 ports (in the front) used, e.g. for connecting USB flash drives
- 1 auxiliary LAN connector (RJ45 port)

The system, including the Experiment Cubes, is monitored and operated from ground.

Nominal interventions of the astronauts are limited to activation of power switch, exchange of Experiment Cubes and, if requested, installing/removing the SSD and USB flash drives used for collection of large amounts of scientific data to be physically downloaded to ground.



Figure 2 Framework features

ICE Cubes Facility to Experiment Cube IRD

**2.3 “Internal” Experiment Cubes**

The “internal” Experiment Cubes (hereafter referred to as “Experiment Cubes” or “Cubes”) can vary per experiment but will all have to meet basic interface requirements with the Framework such as modular size, weight, interface, maximum allowable power, etc.

The size of the Experiment Cubes is set to mimic the CubeSat standard, i.e. 10x10x10cm (1 litre) for a 1U Experiment Cube, 20x10x10cm for a 2U Experiment Cube, etc. with one principal difference: the Experiment Cubes can be scaled along two axes in order to offer more flexibility to customers.

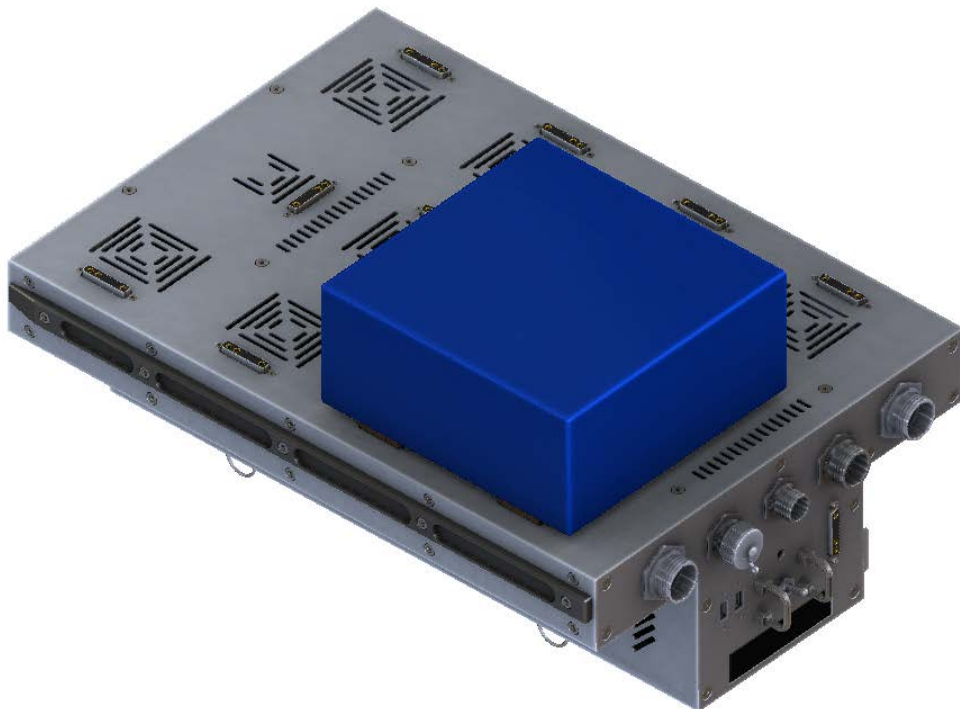

**Figure 3 Framework with one 2Ux2U Experiment Cube**



**Figure 4 1U Experiment Cube with protruding male DB13W3P connector**



ICE Cubes Facility to Experiment Cube IRD

The Experiment Cubes can be functionally interconnected via the network offered by the Framework. The ICF housekeeping and the scientific data will be stored on a removable SSD and will be downlinked to ground according to the capabilities offered by the ISS infrastructure.

Different voltages (5V and/or 12V) and power profiles are available for each Experiment Cube location.

**2.4 “External” Experiment Cubes and Other Payloads**

For “external” Experiment Cubes or other payloads to be physically accommodated outside the ICF and connected via Wi-Fi or via the front DB13W3S female receptacle of the Framework, please contact the ICE Cubes service.

The concept for the accommodation of wired external payloads is shown in Figure 5. The “external” Cube could for example be attached via a bogen arm to the seat track next to the ICF.

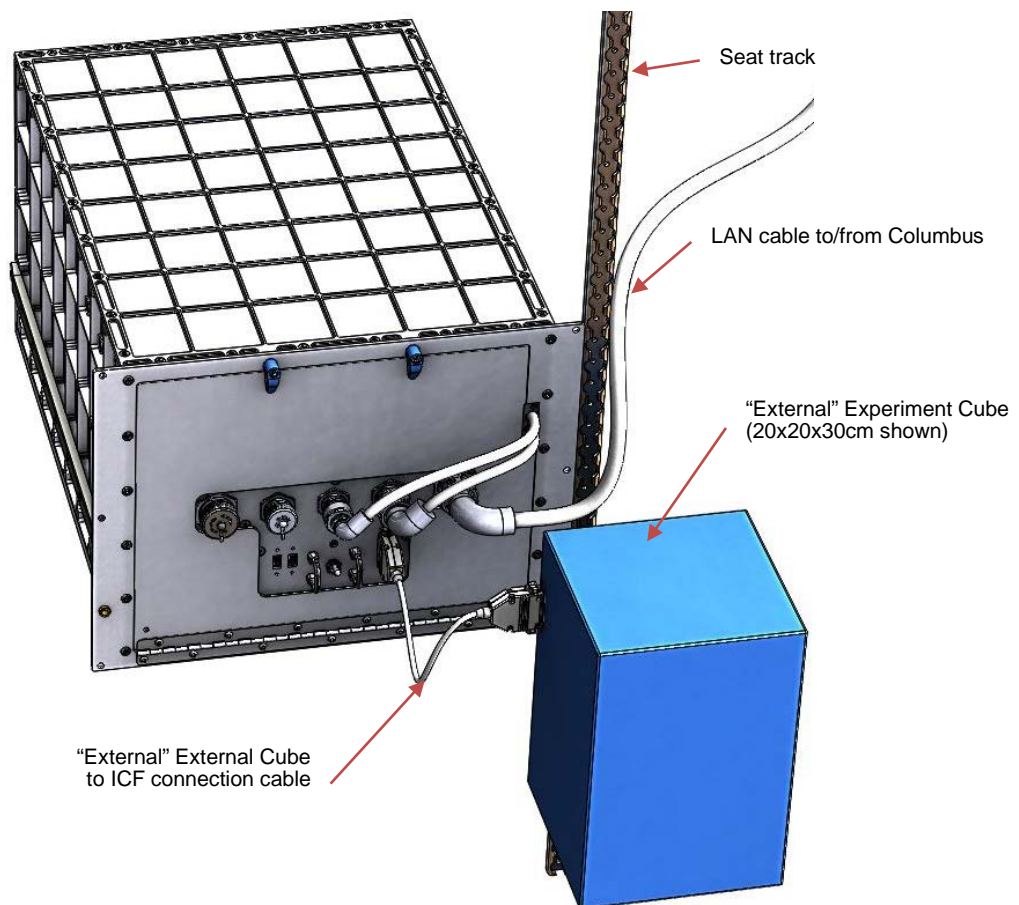

**Figure 5 Accommodation of wired external payload (concept)**

ICE Cubes Facility to Experiment Cube IRD

2.5 Thermal Cooling

The ICF thermal dissipation concept is based on forced air cooling provided by the hosting rack.

The warm air is sucked from air outlets located on the rear panel of the Container, while the cold air enters from the inlets on the side walls of the Container.

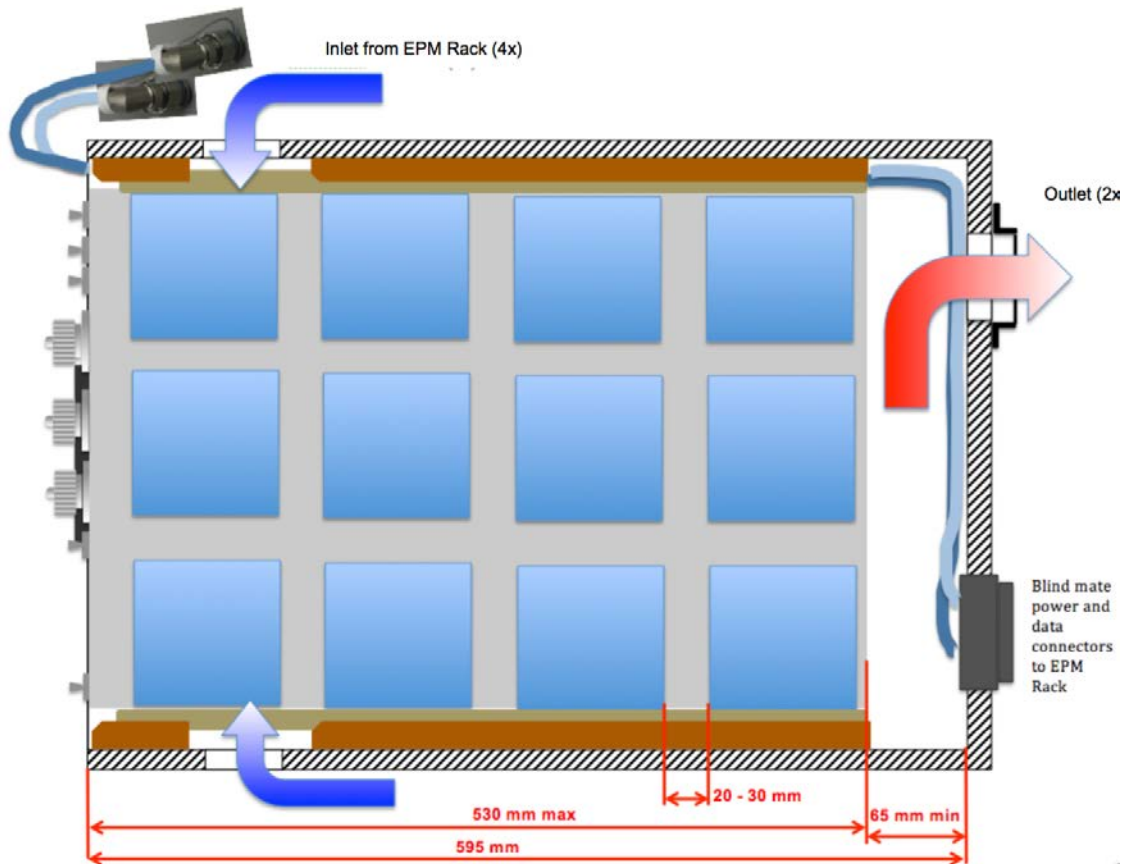

Figure 6 Schematics of the forced air cooling inside the ICF Container

ICE Cubes Facility to Experiment Cube IRD

### 3 Experiment Cube Flight Interface Requirements

#### 3.1 Mechanical Requirements

##### 3.1.1 Experiment Cube Connector



Figure 7 DB13W3P male plug (Cube side)

The Experiment Cube shall have a DB13W3P male connector protruding from one external Cube wall (cf. Figure 4). This protrusion ( $p$  in Figure 8) shall be comprised between 3 and 7.2 mm (TBC).

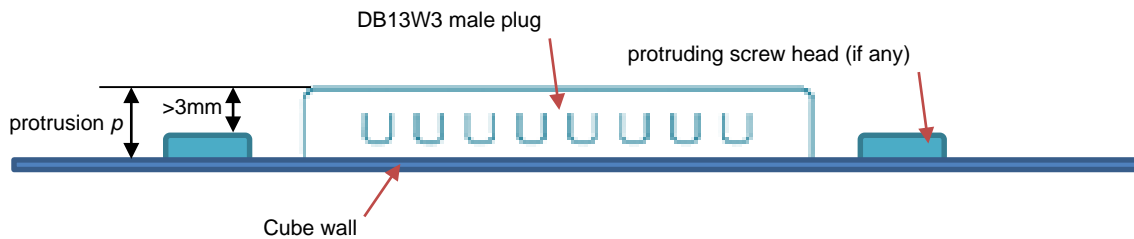

Figure 8 Protrusion of the DB13W3P male connector from the Cube wall

A mechanical interface drawing of the DB13W3P connector that is required for compatibility with the ICF is included in Appendix B.1.

The positioning of the connector on the Cube shall comply with Figure 9.



ICE Cubes Facility to Experiment Cube IRD

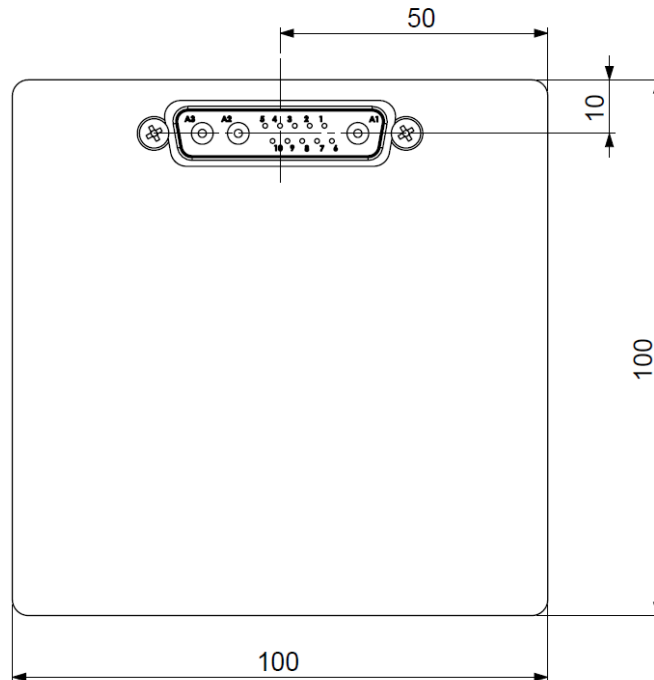

**Figure 9 Proper positioning of the DB13W3P male connector on a 1U Cube (dimensions in mm)**

### 3.1.2 Outer Surfaces

No object or element shall protrude from the external walls of the Experiment Cube, with the following exceptions:

- the aforementioned connector (see req. 3.1.1),
- heads of eventual screws fastening the aforementioned connector (cf. Figure 8 and Appendix B.2),
- heads of eventual screws fastening the Experiment Cube walls (see also req. 3.1.6),
- eventual fins (see req. 3.1.3).

*Note: Cubes requiring a different setup need prior approval from the ICE Cubes service.*

### 3.1.3 Vents & Fins

For Experiment Cubes requiring vents and/or fins, please coordinate with the ICE Cubes service for more information and approval.

### 3.1.4 Standard Form Factors

The Experiment Cube can range in size from 1U to 4Ux3U, as illustrated in Figure 10.

ICE Cubes Facility to Experiment Cube IRD

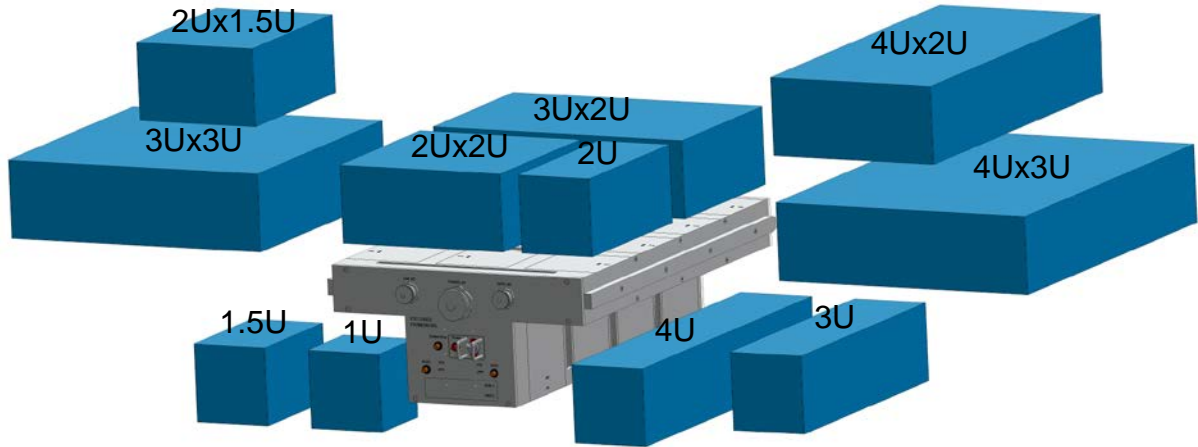

Figure 10 Experiment Cube standard form factors

3.1.5 Dimensions & Tolerances

The Experiment Cube shall have external dimensions as per one of the lines in Table 1.

Cube Form Factor	Cube External Dimensions*
1U	100mm x 100mm x 100mm
1.5U	162.5mm x 100mm x 100mm
2U	225mm x 100mm x 100mm
3U	350mm x 100mm x 100mm
4U	475mm x 100mm x 100mm
2U x 1.5U	225mm x 162.5mm x 100mm
2U x 2U	225mm x 225mm x 100mm
3U x 2U	350mm x 225mm x 100mm
3U x 3U	350mm x 350mm x 100mm
4U x 2U	475mm x 225mm x 100mm
4U x 3U	475mm x 350mm x 100mm

\* excluding the exceptions per requirement 3.1.2

Table 1 Experiment Cubes standard external dimensions

Note: Cubes requiring different dimensions need prior approval from the ICE Cubes service.

Dimensions shall have standard tolerances, as specified in ISO 2768-1 [RD8] for linear and angular dimensions and in ISO 2768-2 [RD9] for features. The applicable tolerance classes are “m” and “K”, respectively.

3.1.6 Sharp Edges

To prevent inadvertent injury to the astronauts, the external surfaces of the Experiment Cube shall not have sharp edges, sharp corners and/or sharp protrusions.

The sharp edges verification shall make use of a cotton glove that should not be snagged as it passes over all of the Cube surfaces (including the protruding connector, etc. per req. 3.1.2).

**ICE Cubes Facility to Experiment Cube IRD**

---

**3.1.7 Audible Noise**

**3.1.7.1 Continuous Noise Limits**

The total Sound Pressure Level (SPL) generated by the Experiment Cube shall not exceed the NC-35 level defined in Table 2 in any octave band between 63Hz and 8000Hz when measured at 0.61m from any of the Cube's surfaces.

<b>Frequency (Hz)</b>	63	125	250	500	1000	2000	4000	8000
<b>NC-35 SPL (dB)</b>	60	52	45	40	36	34	33	32

**Table 2 Continuous noise limits**

*Note: NC-35 is the apportionment of the requirement to each single Experiment Cube.*

**3.1.7.2 Intermittent Noise Limits**

In case of intermittent utilization of the Experiment Cube, i.e. less than 8 hours of continuous use, the acceptable noise limits can be higher than the values defined in Table 2 and they shall be agreed with the ICE Cubes service.

**3.1.7.3 Audible Noise Limits Verification**

The requirements of audible noise produced by the Experiment Cube can be verified by:

- Analysis based on the datasheets of the commercial parts, if available
- Test

The test setup and procedure (including success criteria) shall be agreed between the ICE Cubes service and the customer.

**3.1.8 Microgravity Disturbances**

Microgravity disturbances generated by the Experiment Cube at the level of the mechanical interface with the ICF shall be limited, as follows:

TBW

If an Experiment Cubes contains moving parts and a test is deemed necessary, the test setup and procedure (including success criteria) shall be agreed between the ICE Cubes service and the customer.

**3.2 Structural and Environmental Interface Requirements**

**3.2.1 Environmental Conditions**

**3.2.1.1 Transport, Storage and Launch in Unpowered Conditions**

The Experiment Cube shall withstand the ISS, HTV, Progress, Soyuz, SpaceX Dragon, and Orbital Cygnus depressurization and re-pressurization, humidity, temperature and atmospheric pressure requirements as summarized here below (from COL-RIBRE-SPE-0164 [RD3] and SSP 50835 [RD4]).

**ICE Cubes Facility to Experiment Cube IRD**

The maximum depressurization/re-pressurization rates during transport (ascent/descent) are 13.3 kPa/s and 798 Pa/s, respectively.

The depressurization/re-pressurization rates on board the ISS are 878 Pa/s (for at least 2 min, starting at ambient pressure), and 230 Pa/s (for at least 3 min, starting at p = 100 Pa).

Additionally, the Cube shall be compatible with the pressure gradient that may occur due to fire suppression in the rack where the ICF is hosted, with a peak pressurization rate of 20 kPa/s (for less than 0.1 second in the case of manual fire suppression).

The Experiment Cube shall withstand the environmental requirements given in the following table:

	Temperature (°C)	Pressure (mbar)	Maximum Relative Humidity (%)
<b>Storage</b>	+5 to +35	942 to 1050	85
<b>Transport</b>	-10 to +50*	150 to 1060	90
<b>Accommodation into launcher</b>	0 to +50	600 to 1293	85
<b>Launch / Ascent</b>	0 to +50	0 to 1293	90 (100 depressed)
<b>On Orbit (on board the ISS) non operational</b>	+0 to +50	0 to 1050	70 (100 depressed)
<b>Descent / Landing</b>	0 to +48,9	0 to 1293	90 (100 depressed)

\* In the event of a launch in Progress or Soyuz, the temperature range requirement during transportation by train to the launch site is actually -50°C to +50°C. However, this temperature range can be narrowed to -10°C to +50°C by shipping the hardware items from Space Applications Services' premises to the launch site in such a way that no transportation in an uncontrolled temperature environment takes place (as it has been done in the past for other projects). Therefore, it is considered appropriate to verify compliance of the Experiment Cube design against the -10°C to +50°C range.

**Table 3 Environmental conditions (unpowered)**

For Experiment Cubes with special temperature and/or humidity control requirements (on board, during launch, and/or return to ground), please coordinate with the ICE Cubes service.

**3.2.1.2 Thermal Environment inside the ICE Cubes Facility**

The cooling of the Experiment Cube is obtained via forced air ventilation inside the ICF.

The temperature of the cooled air flow entering the ICF Container can range between 17°C and 30°C (hosting rack design values). Measurements performed in the past range between 20°C and 25°C.

Approximate temperature of the air surrounding the Experiment Cube, if requested, can be offered by proper location of the Cube itself in the ICF.

Fine temperature control shall be implemented at Cube level by the introduction of heaters, vents, fins (see req. 3.1.3) or Peltier coolers, as necessary.

**3.2.2 Launch & Landing Loads**

The Experiment Cube safety-critical structures shall provide positive margins of safety when exposed to the accelerations documented in Table 4 at the centre of gravity of the Cube packed in foam (soft packaging provided by the ICE Cubes service), with all six degrees of freedom acting simultaneously.

**ICE Cubes Facility to Experiment Cube IRD**

	<b>Nx (g)</b>	<b>Ny (g)</b>	<b>Nz (g)</b>	<b>Rx (rad/s<sup>2</sup> )</b>	<b>Ry (rad/s<sup>2</sup> )</b>	<b>Rz (rad/s<sup>2</sup> )</b>
<b>Launch</b>	+/-7.4	+/-7.4	+/-7.4	+/-13.5	+/-13.5	+/-13.5
<b>Landing</b>	+/-10.0	+/-10.0	+/-10.0	N/A	N/A	N/A

**Table 4 Launch and landing load factors envelope**

Safety-critical structures within an Experiment Cube will be identified by the ICE Cubes service, based on the peculiarities of the Experiment Cube.

**3.2.3 Random Vibration Loads**

The Experiment Cube safety-critical structures packed soft stowed in bags (soft packaging provided by ICE Cubes service) shall meet the specified performance requirements when exposed to the maximum flight random vibration environments defined in Appendix C (from Table 3.1.1.2.1.2.3.1-1 of SSP 50835 [RD4]).

Mechanical drawings of structurally qualified Cubes will be included in Appendix B.3. Cubes built according to these drawings do not necessitate structural analysis and testing until the limits of mass distribution (TBD) are observed.

For Experiment Cubes with different structure requirements and/or for establishing the proper vibration test for your Cube, please coordinate with the ICE Cubes service.

**3.2.4 Shock Loads**

The Experiment Cube packed in foam will not experience significant mechanical shock. Shock verification is not required for launch and return events.

Any mechanical or electrical components that are highly sensitive to shock should be assessed on a case-by-case basis with the help of the ICE Cubes service.

**3.3 Thermal Requirements**

**3.3.1 Temperature Control**

For Experiment Cubes with special temperature control requirements (on board, during launch, and/or return to ground), please coordinate with the ICE Cubes service.

**3.3.2 Touch Temperature**

Under all modes of operation, the powered Experiment Cube shall have no external metallic surfaces exceeding the temperature of 45°C.

**3.3.3 Thermal Sensor**

Although in principle not needed, the implementation of thermal sensor(s) in the Experiment Cube may be requested by the ICE Cubes service on a case-by-case basis.

**3.3.4 Condensation Prevention**

Under all modes of operation, no condensation shall occur in the internal parts or on the external surface of the Experiment Cube.

ICE Cubes Facility to Experiment Cube IRD

3.4 Electrical Interface Requirements

3.4.1 DB13W3 Connector Proprietary Wiring

The Experiment Cube shall comply with the following proprietary pin assignment (see also req. 3.6.6).

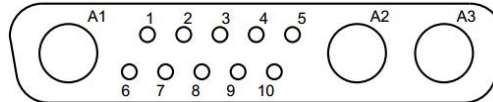

Figure 11 DB13W3S schematic (receptacle, Framework side)

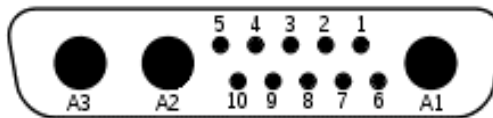

Figure 12 DB13W3P schematic (plug, Cube side)

A1	A2	A3	1	2	3	4	5	6	7	8	9	10
+12V	GND	+5V	B+/R+	B-/R-	C+	C-	CD	A+/T+	A-/T-	D+	D-	SHLD

(A to D = bidirectional Gigabit Ethernet data pairs, T = Transmit, R = Receive;  
GND = Ground; CD = Cube Detection; SHLD = Ethernet cable shield)

Figure 13 DB13W3 pin assignment

The Cube Detection circuit enables to detect the presence of a recognized plugged Cube. As such, pin 5 shall be properly terminated in the Experiment Cube, as follows:

- Unless otherwise specified: electrical resistance = 0 Ω (short to ground).
- For specific cases (e.g. non-IP-enabled Cubes): resistance value between 12 kΩ and 220 kΩ to be assigned by the ICE Cubes service.

In case 5V power is not required, the unused pin A1 shall be left unconnected in the Experiment Cube (isolation resistance to all other pins >10MΩ).

In case 12V power is not required, the unused pin A3 shall be left unconnected in the Experiment Cube (isolation resistance to all other pins >10MΩ).

3.4.2 Power

The Experiment Cube can make use of two different power lines: 5V @ 0.9A (thus 4.5W maximum) and 12V @ 3A (thus 36W maximum).

The maximum amount of power delivered to the Experiment Cube depends on its capability to dissipate heat through its external surfaces (i.e. on its geometry).

For preliminary design purposes, the following maximum power consumptions shall be considered: 10W for 1U, 15W for 1.5U, 20W for 2U, 30W for 3U and 40.5W for 4U and bigger sizes (cf. §3.1.5).

For Experiment Cubes with higher power requirements, please coordinate with the ICE Cubes service.

---

**ICE Cubes Facility to Experiment Cube IRD**

---

**3.4.3 Unexpected Power Loss**

The Experiment Cube shall be able to safely withstand unexpected power loss and multiple power cycles, resulting from normal operations on board the ISS.

**3.5 Electromagnetic Compatibility (EMC) Requirements****3.5.1 Grounding, Bonding & Isolation****3.5.1.1 Grounding (i.e. Ground Return)**

The grounding (i.e. input power ground return) of the Cube shall be exclusively implemented via pin A2 (GND) in the Cube DB13W3P connector.

**3.5.1.2 Bonding (i.e. Chassis Ground)**

There shall be no floating metal within the Experiment Cube, i.e. all substantial metallic part shall be bonded.

Preferred bonding strategy: the Experiment Cube shall be bonded to the ICF via the metallic frame of the DB13W3 interface connector (there is no bonding strap between the Experiment Cubes and the ICF).

The Experiment Cube shall have a bonding resistance  $\leq 2.5 \text{ m}\Omega$  DC per bonding junction between:

- different parts of the Cube metallic structure,
- DB13W3P connector shell and Cube metallic structure,
- internal bonding straps, if any, and Cube metallic structure.

In case an isolating DC/DC converter is used downstream of the DB13W3P connector, the secondary power ground return shall be connected to the DB13W3P shell with a bonding resistance  $\leq 2.5 \text{ m}\Omega$  DC.

Preferred bonding strategy for the shield: the Experiment Cube shall have a bonding resistance between cable shield termination (Cube DB13W3P connector pin 10) and DB13W3P shell  $\leq 7 \text{ m}\Omega$  DC.

Optional bonding strategy: the Cube metallic structure may be used as power ground return (e.g. multipoint ground) and thus isolated from the DB13W3P shell (cf. req. 3.5.1.3). In such a case, the Experiment Cube shall have a bonding resistance  $\leq 2.5 \text{ m}\Omega$  DC per bonding junction between:

- different parts of the Cube metallic structure,
- internal bonding straps, if any, and Cube metallic structure.

Optional bonding strategy for the shield: the Experiment Cube cable shield termination (Cube DB13W3P connector pin 10) shall be connected to the power ground return (pin A2) with a  $10\text{M}\Omega$  to  $40\text{M}\Omega$  resistor.

**3.5.1.3 Isolation**

The isolation resistance between the Cube DB13W3P connector shell and pins 1, 2, 3, 4, 6, 7, 8, 9 of the DB13W3P connector shall be  $> 10\text{M}\Omega$ .

ICE Cubes Facility to Experiment Cube IRD

The isolation resistance between the Cube DB13W3P connector shell and pins A1, A2 and A3 of the DB13W3P connector shall be  $> 10M\Omega$ .

The capacitive coupling between the Cube DB13W3P connector shell and pins A1, A2 and A3 of the DB13W3P connector shall be  $< 220nF$ .

The isolation resistance between pin A1 and pin A3 of the Cube DB13W3P connector shall be  $> 10M\Omega$ .

**3.5.2 Electromagnetic Interference**

**3.5.2.1 Radiated Emissions**

Narrowband electric field at 1m from the Experiment Cube installed on the ICF shall not exceed the limits of Figure 14 in the frequency range 14 kHz to 10 GHz.

Additionally, the following limits shall not be exceeded in the following frequency ranges:

- 55 dB $\mu$ V/m in the range 2.2 to 2.4 GHz
- 36 dB $\mu$ V/m in the ranges 250 to 300 MHz and 420 to 423 MHz

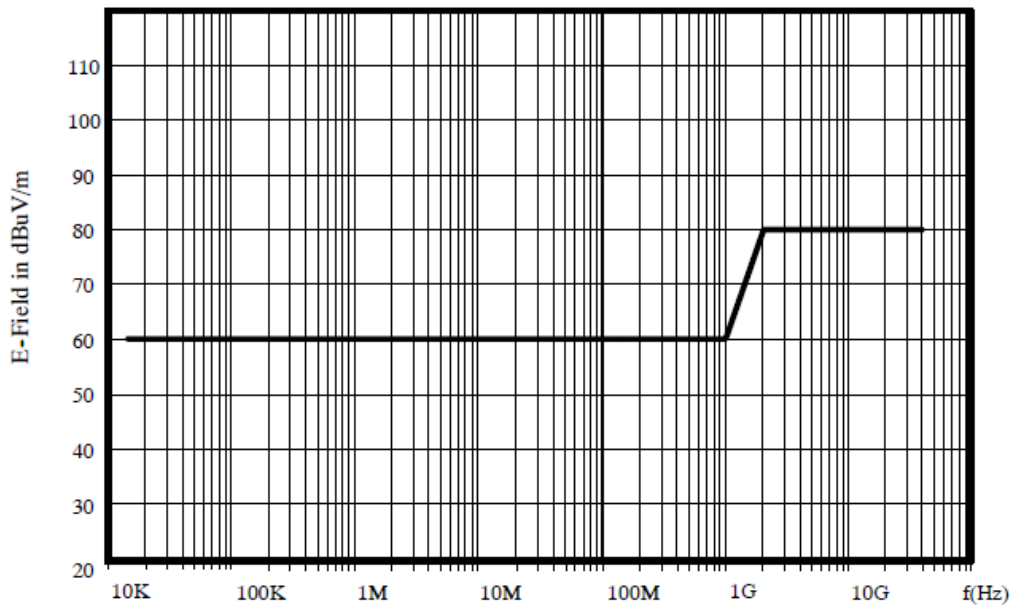

Figure 14 Narrowband radiated emission limits

**3.5.2.2 Conducted Emissions**

TBW

**3.5.2.3 Radiated Susceptibility**

The Experiment Cube shall not exhibit any malfunction, degradation or deviation of performances when irradiated with fields as defined in Figure 15 up to 10 GHz.



ICE Cubes Facility to Experiment Cube IRD

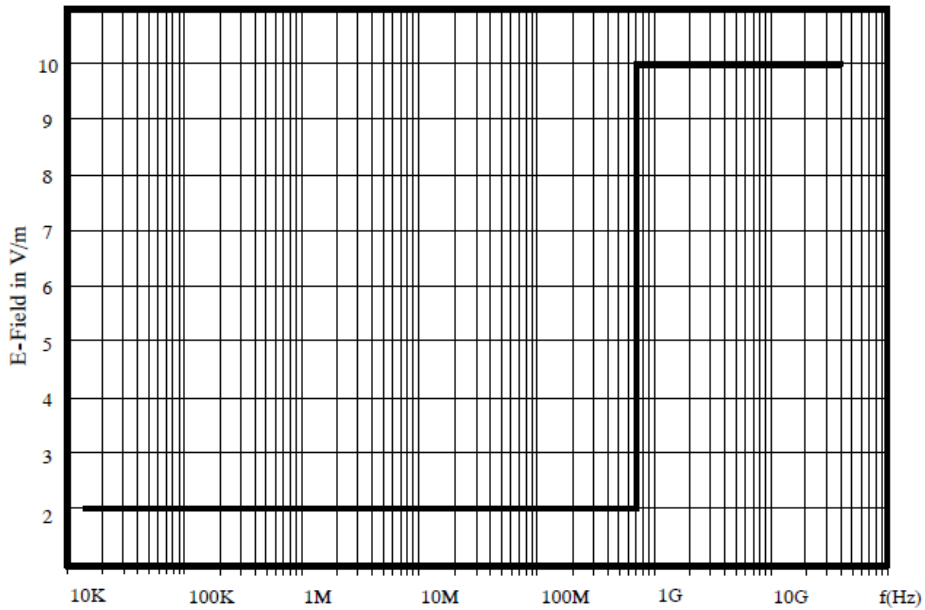

Figure 15 Radiated susceptibility E-field limit

3.5.2.4 Conducted Susceptibility

DC Power Bus Transient

The Experiment Cube shall not exhibit any malfunction, degradation of performance or deviation from specified parameters beyond tolerances given by the corresponding specification, when the test spikes having the waveform and the amplitude of twice the supply voltage shown in Figure 16 are applied to the DC power input leads for a period of not less than 1 minute at each phase position, and for a total test period not exceeding 15 minutes in duration.

- Spike #1 E= Twice the nominal line voltage;  $t_1=10\mu s \pm 20\%$
- Spike #2 E= Twice the nominal line voltage;  $t_2=0.15\mu s \pm 20\%$

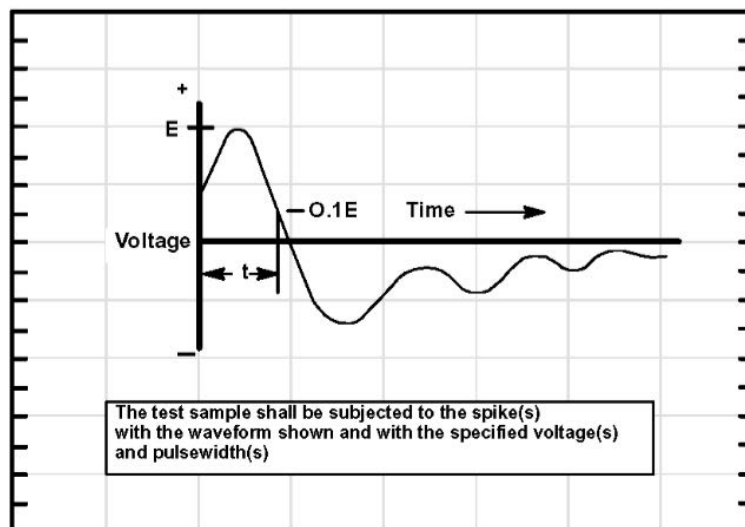

Figure 16 Transient pulse definition

---

**ICE Cubes Facility to Experiment Cube IRD**

---

**3.5.2.5 Electromagnetic Interferences Verification**

Electromagnetic emissions produced by the Experiment Cube shall be measured in a test environment. The test setup and procedure (including success criteria) shall be agreed between the ICE Cubes service and the customer.

**3.5.3 Electrostatic Discharge (ESD)**

The unpowered Experiment Cube shall not be damaged by ESD  $\leq 4\text{kV}$  to its external surface or any pin on its external connector.

The customer shall notify if the Cube may be damaged by ESD between 4 and 15 kV, and, in such case, a dedicated label (provided by the ICE Cubes service) shall be affixed on the Cube external surface.

*Note: These voltages are the result of charges that may be accumulated and discharged from ground personnel or astronauts during equipment installation or removal.*

**3.5.4 DC Magnetic Fields**

For Experiment Cubes featuring electromagnetic and/or permanent magnetic devices, the generated DC magnetic fields shall not exceed 170 dB picotesla at a distance of 7 cm from the generating device.

**3.6 Data & Communication Interface Requirements**

The ICF offers a number of communication interfaces to operate the Experiment Cubes. The use of each of the communication interface is optional and depends of the needs of the specific Cube.

The communication interfaces include:

- IP communication
- Data synchronization
- Telemetry (TM) & telecommand (TC)
- Download of data

Each of those interfaces are described in the following sections.

**3.6.1 Experiment Cube IP Communication**

Multiple UHBs may be defined for interacting with an Experiment Cube, however only one at a time will be able to operate the Cube in question.

*Note: Each UHB needs to fulfil the security requirements described in req. 4.2.2.3 and req. 4.2.2.4.*

For communicating with a specific Experiment Cube, the UHB(s) shall make use of the private IP address assigned by the ICMCC to the Experiment Cube.

An Experiment Cube using IP communications shall answer the incoming ICMP requests (ping) in order to assess the connectivity status of the Experiment Cube.

For initiating outgoing connections, from the Experiment Cube to the ground, a ground IP address will be assigned by the ICMCC to the related UHB. The Experiment Cube shall use this address to establish IP communication to a specific UHB.

**ICE Cubes Facility to Experiment Cube IRD**

---

The Experiment Cube requiring direct control from ground using Internet protocols may for example implement an SSH server.

Data communication to and from the Experiment Cube will only be allowed using the Internet protocols listed in Table 5.

Internet Layer	Transport Layer	Application Layer
ICMP		
IPv4	TCP	HTTP
		HTTPS/SSL
		Opus
		RDP
		SSH
		SFTP, SSH
		SSL/TLS
		VNC/Remote Desktop, RFB
		mobiNET (proprietary)
		VP8/HTTP
IPv4	UDP	CFDP, CCSDS Stack
		DDS, RTPS
		RTP, RTCP
		RTSP
IP	GRE	GRE

**Table 5 ICE Cubes Internet protocols**

The utilization of protocols not included in Table 5 shall be coordinated with the ICE Cubes service.

**3.6.2 Experiment Cubes Data Synchronization Service**

As a result of normal operations on board the ISS, the Experiment Cube will experience periods of Acquisition of Signal (AOS), during which near real-time communications are possible, and of Loss of Signal (LOS), during which no data can be transferred to/from Earth.

During AOS periods, the Experiment Cube science data can be directly downlinked to Earth using near real-time IP-based communication. However, this communication will stop during periods of LOS and may result in a loss of data.

Alternatively, the Experiment Cube can make use of the data synchronization service provided by the ICE Cubes service. The Cube data will be automatically downlinked to ground or uplinked to the ICF (see req. 4.2.3.1 and 4.2.3.2) whenever possible.

To use the data synchronization service, the Experiment Cube shall have an SFTP client installed.

The space reserved to each Experiment Cube for temporary storage of data on the ICF data storage media is predefined based on the specific need of the Experiment Cube.

*Note: The data will not be purged by the ICE Cubes service as long as the Experiment Cube is in orbit. This is a responsibility of the customer.*

---

**ICE Cubes Facility to Experiment Cube IRD**

---

**3.6.3 Telemetry (TM) & Telecommand (TC)**

Optionally, a Cube can use the Telemetry (TM) & Telecommand (TC) service provided by the ICF.

The service can be used to:

- Downlink the Health and Status (H&S) and Housekeeping (HK) data of the Experiment Cube.
- Uplink telecommands (TC) to the Experiment Cube.

The service provides the following advantages:

- Provides an archive on the ground of the TM and TC produced by the Experiment Cube.
- Guaranties the delivery of the TM data produced during LOS periods: telemetry packets lost during LOS are downlinked by the ICF during the next AOS and the TM archive is consolidated on the ground.
- Allows a Cube ground station to use the Mission Control System client Yamcs Studio to monitor and control the Experiment Cube.

The Experiment Cube shall implement this service following the ICE Cubes data format as defined in ICU-SA-RQ-007 [AD1].

**3.6.4 Experiment Cube Download of Data**

For Experiment Cubes requiring the physical download of their data, a flight-worthy USB flash drive (Type-A plug) of sufficient size shall be provided.

**3.6.5 Experiment Cube Security**

Experiment Cubes (whose architecture support antimalware) using the IP services for data transmission shall have and use antivirus protection.

The virus signature definitions list of the Experiment Cube shall be updated by the customer periodically (periodicity: quarterly, as defined in OB\_SEC\_0005 of ESA-ISS-COL-SEC-RS-0002 [RD7]).

**3.6.6 Gigabit Ethernet Interface**

IP-enabled Experiment Cubes shall be compatible with Ethernet (10/100/1000base-T auto-negotiation supported), with pin assignment as per requirement 3.4.1.

Non-IP-enabled Cubes (i.e. electrical only Cubes) shall not populate the Ethernet pins of the connector on the Cube side (i.e. pins 1 to 4 and 6 to 9 shall not be present in the DB13W3P male plug).

**3.6.7 Intentional Transmitters and Receivers**

For Experiment Cubes needing an intentional transmitter and/or receiver, please coordinate with the ICE Cubes service.

Intentional transmitters and/or receivers embedded on COTS parts but not used by the Experiment Cube shall be physically removed.

---

**ICE Cubes Facility to Experiment Cube IRD**

---

**3.7 Materials Requirements****3.7.1 Declared Materials List**

Experiment Cube materials and external surface colours shall be agreed between the ICE Cubes service and the customer. To that effect, a Declared Materials List (DML) shall be submitted to the ICE Cubes service.

**3.7.2 Forbidden Materials and Components**

The following constitute a hazard and are prohibited from being used without prior approval from the ICE Cubes service: beryllium (for structures), beryllium oxide, mercury, cadmium, lithium, magnesium, zinc, polyvinyl chloride (PVC), radioactive materials, polyamide insulated cables, wet slug tantalum capacitors.

**3.7.3 Surface Treatments & Protective Coatings**

Treatments and/or protective coatings applied to any surfaces of the Experiment Cube shall be agreed between the ICE Cubes service and the customer.

For Experiment Cubes with an aluminium alloy structure, the following three treatments are allowed: alodine, black anodization and nickel plating.

For Experiment Cubes requiring other structure materials, please coordinate with the ICE Cubes service for more information and approval.

**3.7.4 Flammability**

Selected materials for the Experiment Cube shall be non-flammable (i.e. considered self-extinguishing) in accordance with the standards ISO 14624-1 [RD10] or ISO 14624-2 [RD11], and/or with a UL 94 [RD12] flammability rating V-0 or higher (i.e. 5VB or 5VA).

If lower classified (i.e. less flame-retardant) or even flammable materials must be used due to project constraints, adequate flammability control shall be demonstrated at Cube level, with the help of the ICE Cubes service, through configuration analysis or test.

**3.7.5 Offgassing**

Offgassing evaluation by analysis and/or test is required only for Experiment Cubes with non-metallic mass greater than 9072 grams.

In case it is required, the test setup and procedure (including success criteria) shall be agreed between the ICE Cubes service and the customer.

**3.7.6 Fasteners Locking**

For making use of glue or gels as thread-locker in fastened joints of the Experiment Cube, please coordinate with the ICE Cubes service for preventive authorization.

---

**ICE Cubes Facility to Experiment Cube IRD**

---

**3.8 Safety Requirements****3.8.1 Collection of Safety-Related Data**

The customer shall provide safety-related information about the Experiment Cube as per Table 11 in Appendix D.

**3.8.2 Non-Conformity with Requirements**

Should it prove impossible to comply with one of the requirements of this document, the customer shall indicate:

- the description and reason for non-conformity
- the impact of the non-conformity on safety
- the means proposed to mitigate the impact

**3.8.3 Containment**

In case of utilization of liquids, particulates, microbes, trace gases, etc. inside the Experiment Cube, please coordinate with the ICE Cubes service for containment strategy, materials compatibility, assessment of toxicity or biohazard level, and preventive authorization.

**3.8.4 Volatile Organic Compound**

Small amounts of methanol, ethanol, isopropyl alcohol, n-propyl alcohol, n-butyl alcohol, acetone, ethylene glycol, and/or propylene glycol contained in the Experiment Cube shall be immediately brought to the attention of the ICE Cubes service, as they request a dedicated approval process.

**3.8.5 Shatterable Materials Release**

All shatterable materials shall be contained within the Experiment Cube to prevent fragments from entering the ISS habitable volume.

**3.8.6 Lasers**

For Experiment Cubes with lasers, please coordinate with the ICE Cubes service.

**3.8.7 Batteries**

For Experiment Cubes with battery requirements, please coordinate with the ICE Cubes service.

**3.8.8 Pyrotechnics**

For Experiment Cubes with pyrotechnics requirements, please coordinate with the ICE Cubes service.

**3.8.9 Smoke & Fire Detection**

This function is performed at ICE Cubes Facility level. As such, there is no implication for the Experiment Cube.

**3.8.10 Flight Readiness Certification**

Flight readiness certification is based on reviews of data submitted by the customer. The related schedule will depend on launch readiness deadlines (cf. Table 10 in Appendix D).

---

**ICE Cubes Facility to Experiment Cube IRD**

---

The Experiment Cube shall pass an interface test, a functional test, and additional tests (as per the present IRD), which shall be documented in test reports. Depending on the particularities of the Experiment Cube, extra ad-hoc tests, verifications, and analyses may be requested to pass the safety reviews and get the flight readiness certification.

### **3.9 Human Factor Interface Requirements**

#### **3.9.1 Astronaut Interaction**

The Experiment Cube shall in principle not require specific astronaut interaction (besides the Cube installation on and removal from the ICF).

*Note: Cubes requiring astronaut interaction need prior approval from the ICE Cubes service.*

#### **3.9.2 Identification & Marking**

The Experiment Cube shall be identified with:

1. Cube name
2. Part number
3. Serial number
4. Bar code identifier
5. Name of the customer organization

The ICE Cubes service will supply to the customer the necessary authorized adhesive label reporting the data as per the bullets 1, 2, 3 and 4 above.

For the marking related to customer identification, please coordinate with the ICE Cubes service.

### **3.10 Reliability Requirements**

The customer shall be responsible for the reliability of the Experiment Cube.

For guidance and recommendations on processes, verifications and tests to ensure higher Cube reliability, please contact the ICE Cubes service.



## ICE Cubes Facility to Experiment Cube IRD

## 4 Experiment Cube Ground Interface Requirements

The ground facility or terminal from which the ground user (customer) operates the Experiment Cube on board the ISS is called User Home Base (UHB) in the following section. It is intended to interact with the Experiment Cube using LAN commands as well as TM and TC data processing.

The usage of the ICF IP services by the Experiment Cube is optional and a UHB is not required for a non-IP-enabled Experiment Cube.

The UHB connects with the ICE Cubes Mission Control Centre (ICMCC) via internet, as shown in Figure 17.

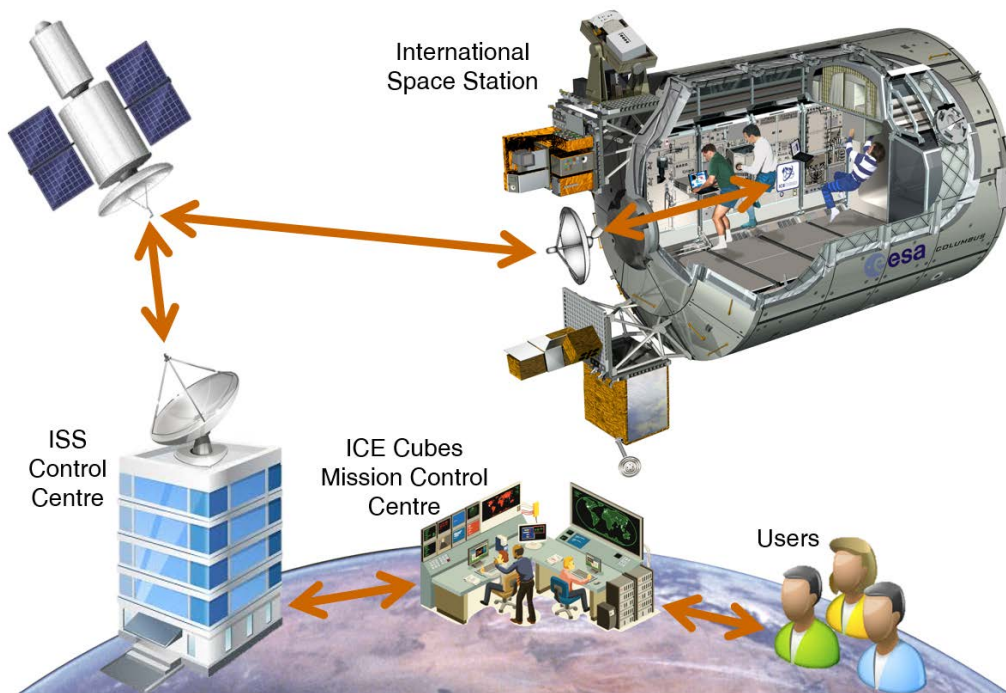

Figure 17 ICE Cubes communications (concept)

### 4.1 Hardware Interface

There is no hardware interface identified between the UHB ground station and the ICMCC.

### 4.2 Software Interface

#### 4.2.1 UHB to ICMCC Interface Overview

The ICMCC offers to a UHB the following services:

- VPN connection via Internet to ICMCC
- ICMCC NTP Service
- Data synchronization Service
- TCP connection to its Experiment Cube private IP



**ICE Cubes Facility to Experiment Cube IRD**

---

- UDP connection to its Experiment Cube private IP
- TCP connection for telemetry (TM) housekeeping packets
- TCP connection for telecommand (TC) packets
- HTTP server for housekeeping (HK) data
- HTTP server for planning and support

The following table lists the IP services offered by the ICMCC to a UHB to communicate with its Experiment Cube and the possible impact of LOS (see req. 3.6.2) on the communication. Interfaces that do not require ground to flight communications are marked as N/A.

Interface	Data recoverable after LOS
VPN connection via Internet to ICMCC	N/A
ICMCC NTP Service	N/A
Data synchronization service	Yes
TCP connection to Experiment Cube private IP	No
UDP connection to Experiment Cube private IP	No
TCP connection for TM housekeeping packets	Yes
TCP connection for TC packets	No
HTTP server for housekeeping (HK) data	N/A
HTTP server for planning and support	N/A

**Table 6 LOS impact on communications between a UHB and its Experiment Cube**

#### **4.2.2 Mandatory Software Interface Requirements**

##### **4.2.2.1 Software Host**

The UHB software shall run on a dedicated COTS hardware machine (e.g. a workstation) provided by the customer.

##### **4.2.2.2 Connection to the ICMCC**

The UHB connection to the ICMCC shall be established as a VPN connection using the OpenVPN client software provided by the ICE Cubes service.

##### **4.2.2.3 Two-Factor Authentication**

To connect to the ICMCC VPN, the UHB ground user shall provide two authentication factors, using a certificate-based PKI eToken (provided by the ICE Cubes service) and a password.

##### **4.2.2.4 Security, Split Tunnelling**

The UHB ground workstation is not allowed to communicate to somewhere else in parallel than the ICMCC while the connection to the ICMCC is active.

---

**ICE Cubes Facility to Experiment Cube IRD**

---

**4.2.2.5 System Time Synchronisation**

The UHB shall synchronize its ground system time by mean of NTP (in accordance with RFC 5905 [RD13]) and synchronize its NTP client with the NTP services of the ICMCC.

**4.2.3 Optional Software Interface Requirements**

The following optional requirements apply only to Experiment Cubes that choose to use the related services provided by the ICF and the ICMCC.

**4.2.3.1 Data Synchronization Service Downlink**

The UHB shall access data files downlinked from the Experiment Cube using the FTP file service provided by the ICMCC. The UHB shall use the FTP protocol and access the FTP server according to the access information provided by the ICMCC.

**4.2.3.2 Data Synchronization Service Uplink**

The UHB shall uplink data files to the Experiment Cube using the FTP file service provided by the ICMCC. The UHB shall use the FTP protocol and access the FTP server according to the access data provided by the ICMCC.

**4.2.3.3 Private IP Address**

The UHB shall request to the ICMCC the private IP address assigned to its Experiment Cube.

**4.2.3.4 Direct TCP and UDP Communication**

The UHB shall communicate with its Experiments Cube at its private IP address using either TCP or UDP protocol, with implementation in accordance with RFC 793 [RD14] and RFC 768 [RD15], respectively.

**4.2.3.5 TCP and UDP Protocol**

The UHB shall communicate with its Experiment Cubes at its private IP address using only the TCP and UDP protocols listed in req. 3.6.1.

**4.2.3.6 UDP Connection**

The UHB application software shall implement an adjustable throttle for outbound UDP uplink data flows.

*Note: The available bandwidth is planned and communicated by the ICMCC.*

**4.3 Experiment Cube Unit-to-System Testing**

The Experiment Cube and the UHB ground application can be interface tested:

- At the Experiment Cube developer location using the software “suitcase simulator” provided by the ICE Cubes service
- At the ICMCC location using the ICMCC end-to-end test environment, with flight-representative on-board interfaces, using the ICF Engineering Model.

**ICE Cubes Facility to Experiment Cube IRD**

## Appendix A Verification Matrix

The abbreviations used in the table are as follows:

Applicability (“Appl.”): A = Applicable; O = Optional; Narr. = Narrative

Verification Method (“Method”): R = Review of Design; I = Inspection; A = Analysis; T = Test

#	IRD §	IRD Requirement	Appl.	Method	Comments
1.	3	Experiment Cube Flight Interface Requirements	Title	-	
2.	3.1	Mechanical Requirements	Title	-	
3.	3.1.1	Experiment Cube Connector	A	R, I, T	
4.	3.1.2	Outer Surfaces	A	R, I	
5.	3.1.3	Vents & Fins	O	R, I	
6.	3.1.4	Standard Form Factors	Narr.	-	
7.	3.1.5	Dimensions & Tolerances	A	R, I	
8.	3.1.6	Sharp Edges	A	I	
9.	3.1.7	Audible Noise	Title	-	
10.	3.1.7.1	Continuous Noise Limits	A	A or T	
11.	3.1.7.2	Intermittent Noise Limits	A	A or T	
12.	3.1.7.3	Audible Noise Limits Verification	A	A or T	
13.	3.1.8	Microgravity Disturbances	A	A or T	TBW
14.	3.2	Structural and Environmental Interface Requirements	Title	-	
15.	3.2.1	Environmental Conditions	Title	-	
16.	3.2.1.1	Transport, Storage and Launch in Unpowered Conditions	A	A or T	
17.	3.2.1.2	Thermal Environment inside the ICE Cubes Facility	A	-	Customer's responsibility
18.	3.2.2	Launch & Landing Loads	A	A or T	
19.	3.2.3	Random Vibration Loads	A	A or T	
20.	3.2.4	Shock Loads	O	A or T	Customer's responsibility
21.	3.3	Thermal Requirements	Title	-	
22.	3.3.1	Temperature Control	O	A or T	
23.	3.3.2	Touch Temperature	A	A or T	
24.	3.3.3	Thermal Sensor	O	R, I, T	
25.	3.3.4	Condensation Prevention	A	A or T	
26.	3.4	Electrical Interface Requirements	Title	-	
27.	3.4.1	DB13W3 Connector Proprietary Wiring	A	R, T	
28.	3.4.2	Power	A	R, T	
29.	3.4.3	Unexpected Power Loss	A	R, T	
30.	3.5	Electromagnetic Compatibility (EMC) Requirements	Title	-	
31.	3.5.1	Grounding, Bonding & Isolation	Title	-	
32.	3.5.1.1	Grounding (i.e. Ground Return)	A	R	

**ICE Cubes Facility to Experiment Cube IRD**

#	IRD §	IRD Requirement	Appl.	Method	Comments
33.	3.5.1.2	Bonding (i.e. Chassis Ground)	A	T	
34.	3.5.1.3	Isolation	A	T	
35.	3.5.2	Electromagnetic Interference	Title	-	
36.	3.5.2.1	Radiated Emissions	A	T	
37.	3.5.2.2	Conducted Emissions			TBW
38.	3.5.2.3	Radiated Susceptibility	A	T	
39.	3.5.2.4	Conducted Susceptibility	A	T	
40.	3.5.2.5	Electromagnetic Interferences Verification	A	T	
41.	3.5.3	Electrostatic Discharge (ESD)	A	(I), T	Inspection only in case of dedicated label
42.	3.5.4	DC Magnetic Fields	A	T	
43.	3.6	Data & Communication Interface Requirements	Narr.	-	
44.	3.6.1	Experiment Cube IP Communication	O	T	
45.	3.6.2	Experiment Cubes Data Synchronization Service	O	T	
46.	3.6.3	Telemetry (TM) & Telecommand (TC)	O	T	
47.	3.6.4	Experiment Cube Download of Data	O	I, T	
48.	3.6.5	Experiment Cube Security	A	R, T	
49.	3.6.6	Gigabit Ethernet Interface	A	I or T	
50.	3.6.7	Intentional Transmitters and Receivers	O	R or I	
51.	3.7	Materials Requirements	Title	-	
52.	3.7.1	Declared Materials List	A	R, I	
53.	3.7.2	Forbidden Materials and Components	A	R	
54.	3.7.3	Surface Treatments & Protective Coatings	A	R, I	
55.	3.7.4	Flammability	A	R	
56.	3.7.5	Offgassing	A	A or T	
57.	3.7.6	Fasteners Locking	A	R	If used
58.	3.8	Safety Requirements	Title	-	
59.	3.8.1	Safety Form	A	R	
60.	3.8.2	Non-Conformity with Requirements	A	-	
61.	3.8.3	Containment	A	R, A or T	If needed
62.	3.8.4	Volatile Organic Compound	A	R	If used
63.	3.8.5	Shatterable Materials Release	A	R	If needed
64.	3.8.6	Lasers	A	R	If used
65.	3.8.7	Batteries	A	R	If used
66.	3.8.8	Pyrotechnics	A	R	If used
67.	3.8.9	Smoke & Fire Detection	Narr.	-	

**ICE Cubes Facility to Experiment Cube IRD**

#	IRD §	IRD Requirement	Appl.	Method	Comments
68.	3.8.10	Flight Readiness Certification	A	R, A, I, T	
69.	3.9	Human Factor Interface Requirements	Title	-	
70.	3.9.1	Astronaut Interaction	A	R	If needed
71.	3.9.2	Identification & Marking	A	R, I	Service's responsibility
72.	3.10	Reliability Requirements	A	-	Customer's responsibility
73.	4	Experiment Cube Ground Interface Requirements	Narr.	-	
74.	4.1	Hardware Interface	Narr.	-	
75.	4.2	Software Interface	Title	-	
76.	4.2.1	UHB to ICMCC Interface Overview	Narr.	-	
77.	4.2.2	Mandatory Software Interface Requirements	Title	-	
78.	4.2.2.1	Software Host	A	-	Customer's responsibility
79.	4.2.2.2	Connection to the ICMCC	A	T	If UHB needed
80.	4.2.2.3	Two-Factor Authentication	A	T	If UHB needed
81.	4.2.2.4	Security, Split Tunnelling	A	T	If UHB needed
82.	4.2.2.5	System Time Synchronisation	A	T	If UHB needed
83.	4.2.3	Optional Software Interface Requirements	Narr.	-	
84.	4.2.3.1	Data Synchronization Service Downlink	O	T	
85.	4.2.3.2	Data Synchronization Service Uplink	O	T	
86.	4.2.3.3	Private IP Address	O	T	
87.	4.2.3.4	Direct TCP and UDP Communication	O	T	
88.	4.2.3.5	TCP and UDP Protocol	O	T	
89.	4.2.3.6	UDP Connection	O	T	
90.	4.3	Experiment Cube Unit-to-System Testing	Narr.	-	

ICE Cubes Facility to Experiment Cube IRD

Appendix B Drawings

B.1 Mechanical Interface Drawing to Position the DB13W3P Male Connector on a 1U Cube (dimensions in mm)

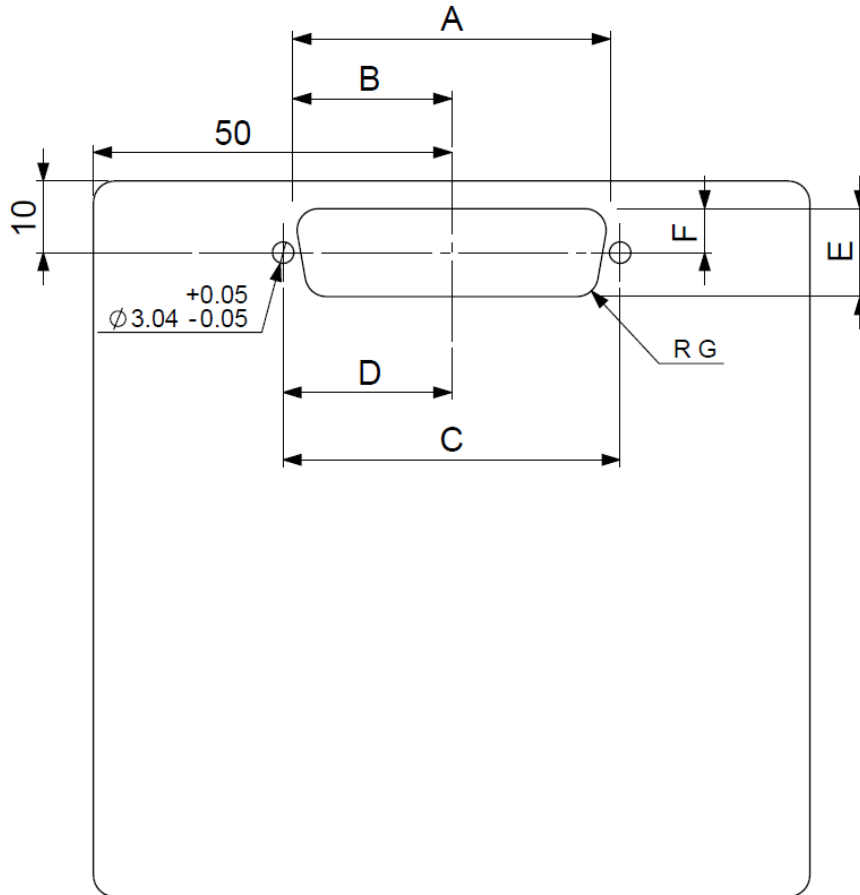

	A	B	C	D	E	F	G
Tolerance	±0.13	±0.13	±0.13	±0.13	±0.13	±0.13	±0.05
Front mounting method	44.27	22.14	47.04	23.52	13.03	6.52	2.10
Rear mounting method	42.51	21.25	47.04	23.52	11.40	5.71	3.35

Table 7 Cut-out dimensions for front and rear mounting methods for DB13W3P connector (mm).

**ICE Cubes Facility to Experiment Cube IRD**

---

**B.2 Mechanical Interface Drawings of Acceptable Protrusions**

To be added in a later issue of the IRD

**B.3 Mechanical Drawings of Structurally-Qualified Cubes**

To be added in a later issue of the IRD

ICE Cubes Facility to Experiment Cube IRD

## Appendix C Random Vibration Loads

The Experiment Cube shall maintain structural integrity (no fracture, disassembly, etc.) when exposed to one of the random vibration environments shown in section C.1 or C.2. The loads are applicable for each axis. The levels shall be applied sequentially with a duration of 60 seconds.

### C.1 Attenuated Random Vibration Environment

Table 8 (based on Table 3.1.1.2.1.2.3.1-1 of SSP 50835 [RD4]) is to be used as input random vibration environment directly on the Cube.

Frequency [Hz]	ASD [g <sup>2</sup> /Hz]	dB change	dB/Oct
20	0.2		
40	0.2		
200	2.5E-4	-29	-12.5
2000	6.25E-7	-26	-7.83
Total g <sub>rms</sub>	2.56		

**Table 8 Random vibration environment attenuated by 76mm of bubblewrap**

### C.2 Unattenuated Random Vibration Environment

Table 9 (based on Table E.2.3-3 of SSP 50835 PIRN 50835-NA-0022B [RD4] plus 3dB positive margin, as specified in §7.4.2 of [RD5]) is to be used as input random vibration environment on a Cube packed in its cushioning launch bag (e.g. bubblewrap).

Frequency [Hz]	ASD [g <sup>2</sup> /Hz]	dB change	dB/Oct
20	0.04		
200	0.04		
2000	0.002	-13.0	-3.92
Total g <sub>rms</sub>	4.53		

**Table 9 Random vibration test profile enveloping Space X Dragon and Orbital Cygnus**



## ICE Cubes Facility to Experiment Cube IRD

## Appendix D Typical Timeline and Required Documents

The following timeline of launch-minus dates are generic. Tailored agreements can be discussed during the contract negotiations.

Event	Date / Launcher	
	Space X	Orbital
Preliminary Launch Manifest	L-11 months	
Final Launch Manifest	L-6 Months	
Flight Safety Review (FSR) Phase II	L-5 months	
FSR Phase III (nominal cargo)	L-12 weeks	L-17 weeks
Cargo Review in Turin (nominal cargo)	L-10 weeks	L-15 weeks
FSR Phase III (late cargo)*	L-8 weeks	
Interface Test in Brussels	L-7 weeks	
Cargo Review in Turin (late cargo)*	L-5 weeks	
Delivery in Houston (in case of direct shipment)* **	L-2 weeks	
Very late (biological) cargo delivery at Launch Site* **	L-3 days	L-7 days

\* Subject to manifesting at L-11 months

\*\* Cargo Review based on pictures. Experiment Cube shipped directly by the customer to Houston (this option is subject to NASA approval)

**Table 10 Experiment Cube Timeline**

Documents to be produced by the customer	Reference*	Format	Due Date (NLT)	Remarks
Experiment Cube's Questionnaire (filled)	ICU-SA-TN-xxx	Word	Initial contact	
Initial Experiments Description	ICU-SA-TN-xxx	Word + Excel	In advance of kick-off	
Experiment Cube to ICE Cubes Service ICD	ICU-SA-ICD-xxx	Word + pdf	L-6 months L-3 months	
Collection of Safety-Related Data	ICU-SA-TN-xxx	Word + pdf	L-6 months L-3 months	To be updated for each FSR phase
Experiment Design/Operations Description and Verification Plan	ICU-SA-RP-xxx	Word + pdf	L-9 months L-5 months	Could be a single document
Experiment Cube Declared Components List	ICU-SA-LI-xxx	Word + pdf	L-6.5 months	
Experiment Cube Declared Materials List	ICU-SA-LI-xxx	Word + pdf	L-6.5 months L-3.5 months	
Experiment Cube Declared Process List	ICU-SA-LI-xxx	Word + pdf	L-3.5 months	
Analysis Reports as necessary for interface- and safety-related verifications	ICU-SA-RP-xxx	Word + pdf	L-6 months	Depending on the Cube characteristics
Test Reports as necessary for interface- and safety-related verifications	ICU-SA-RP-xxx	Word + pdf	L-3 months	Depending on the Cube characteristics
Ancillary documents necessary for shipping				

\* The customer can use his/her own coding for documents reference numbering, if available

**Table 11 Documents to be produced by the customer**